

CLIP-ONS & FIT OVER

centrostyle®
around people







FOR PLASTIC FRAMES

Clip-Ons with minimal mechanism, trimmable lenses and anti-scratch clips for plastic frames. Polarized lenses for maximum protection against UVA and UVB rays.



FOR METAL FRAMES

Clip-Ons with minimal mechanism, trimmable lenses and anti-scratch clips for metal frames. Polarized lenses for maximum protection against UVA and UVB rays.



TRIMMABLE FLIP-UPS

Flip-Ups with minimal mechanism, trimmable lenses and anti-scratch clips. Polarized lenses for maximum protection against UVA and UVB rays.



TRIMMABLE FIXED

Clip-Ons with minimal mechanism, trimmable lenses and anti-scratch clips. Polarized lenses for maximum protection against UVA and UVB rays.

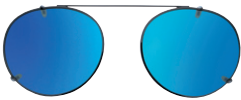

METAL RIM CLIP-ONS

Clip-Ons with anti-scratch clips. Polarized lenses for maximum protection against UVA and UVB rays.



FIT-OVER

To be worn over prescription eyewear. The wrap-around shape protect the eyes from UVA and UVB rays.

pg. 4

pg. 32

pg. 52

pg. 66

pg. 70

pg. 78

FOR PLASTIC FRAMES



Ref. CK0001

Kit of 12 clip-on of your choice

Minimal mechanism for **plastic frame**.



Ref. 11277

Only Couvette

FIXED CLIP-ON WITH MINIMAL MECHANISM

FOR **PLASTIC**
FRAMES

Advice for correct use:

- Do not use force
- Do not try to flip them up

Ref. 12400RG

Spare rubber tips for minimal fixed Clip-Ons
10 pcs.



1.

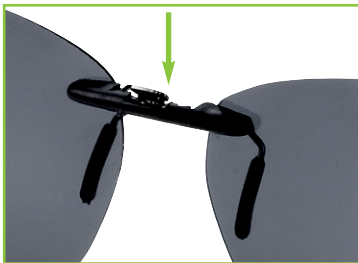

2.



3.



Backing card with technical data and indication of size.

Test the frame for size.

CLIP-ON

for **PLASTIC** frames

54-56

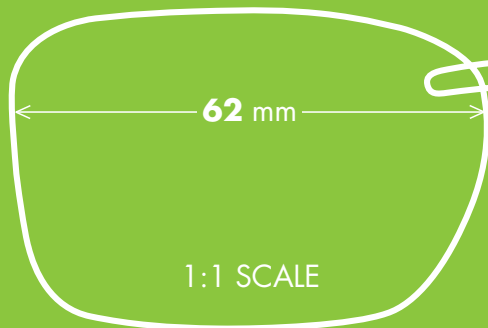

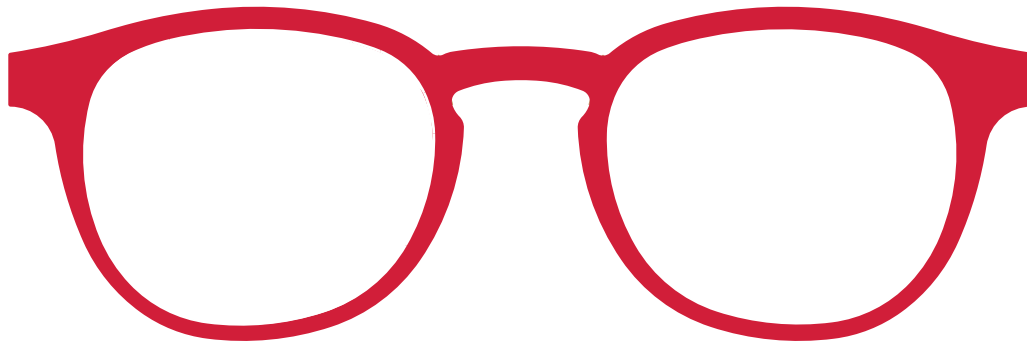

Fixed Clip-On

Suitable for

PANTHOS shapes



■ FOR PLASTIC FRAMES

- Trimmable Lenses
- Anti-scratch hooks
- Case included

FOR FRAME - SIZE 48-50

FIXED



Polarized Lenses 100% UVA-UVB protection up to 390 nm | Filter Category 3 | **CE**



Smoke

Ref. C0275 55 019 001 55



Brown

Ref. C0275 55 019 003 55



G15

Ref. C0275 55 019 002

1 pc.

CE SPECIFICATIONS
IN ACCORDANCE WITH
REGULATION (UE) 2016/425

Case included.



■ FOR PLASTIC FRAMES

- Trimmable Lenses
- Anti-scratch hooks
- Case included

FOR FRAME - SIZE 46-50

FIXED



Polarized Lenses 100% UVA-UVB protection up to 390 nm | Filter Category 3 | **CE**



Grey

Ref. 12792

1 pc.



Brown

Ref. 12793

1 pc.



G15

Ref. 12794

1 pc.

Case included.



■ FOR PLASTIC FRAMES

- Trimmable Lenses
- Anti-scratch hooks
- Case included

FOR FRAME - SIZE 49-53

FIXED



Polarized Lenses 100% UVA-UVB protection up to 390 nm | Filter Category 3 | **CE**



Grey

Ref. C0060 56 019 001



G15

Ref. C0060 56 019 002



Brown

Ref. C0060 56 019 003

1 pc.

CE SPECIFICATIONS
IN ACCORDANCE WITH
REGULATION (UE) 2016/425

Case included.



■ FOR PLASTIC FRAMES

- Trimmable Lenses
- Anti-scratch hooks
- Case included

FOR FRAME - SIZE 49-53

FIXED

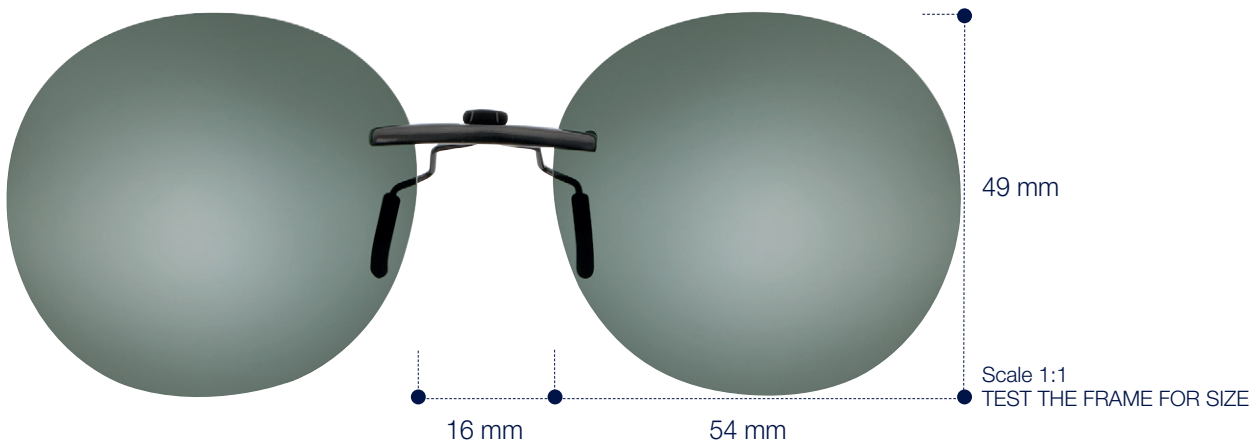

Polarized Lenses 100% UVA-UVB protection up to 390 nm | Filter Category 3 | CE



Grey

Ref. C0097 54 019 001



G15

Ref. C0097 54 019 002

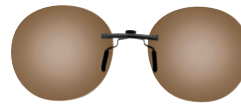

Brown

Ref. C0097 54 019 003

1 pc.



Yellow FC0 polarized

Ref. C0097 54 019 034

1 pc.

Case included.





Fixed Clip-On

Suitable for

CAT-EYE shapes

■ FOR PLASTIC FRAMES

- Trimmable Lenses
- Anti-scratch hooks
- Case included

FOR FRAME - SIZE 52-54

FIXED



Polarized Lenses 100% UVA-UVB protection up to 390 nm | Filter Category 3 | **CE**



Smoke

Ref. C0354 60 019 001



G15

Ref. C0354 60 019 002



Brown

Ref. C0354 60 019 003

 1 pc.

CE SPECIFICATIONS
IN ACCORDANCE WITH
REGULATION (UE) 2016/425

Case included.



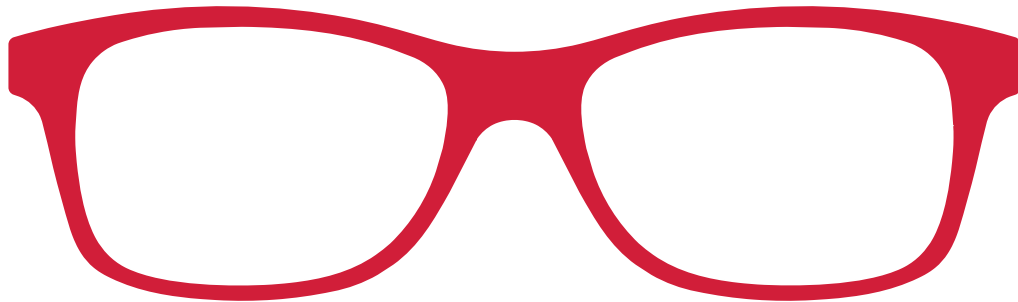
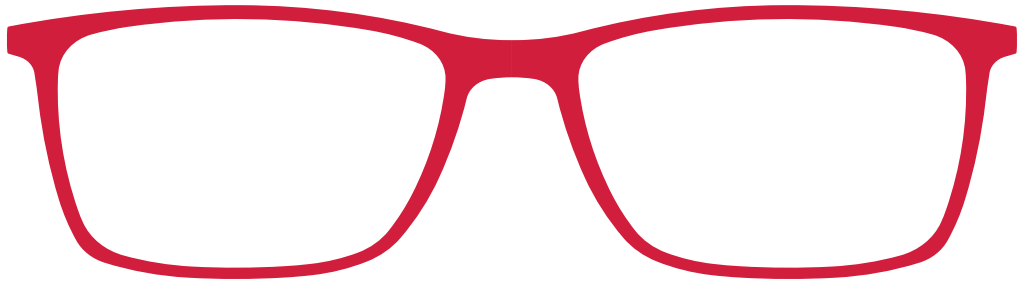

Fixed Clip-On

Suitable for

RECTANGULAR shapes



■ FOR PLASTIC FRAMES

- Trimmable Lenses
- Anti-scratch hooks
- Case included

FOR FRAME - SIZE 50-53

FIXED

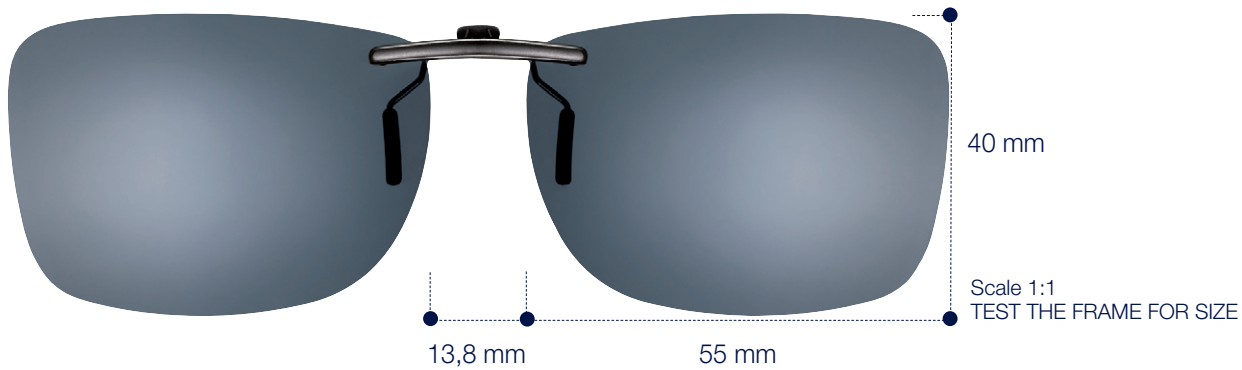

Polarized Lenses 100% UVA-UVB protection up to 390 nm | Filter Category 3 | CE



Grey

Ref. 12777



G15

Ref. 12778

1 pc.

CE SPECIFICATIONS
IN ACCORDANCE WITH
REGULATION (UE) 2016/425

Case included.



■ FOR PLASTIC FRAMES

- Trimmable Lenses
- Anti-scratch hooks
- Case included

FOR FRAME - SIZE 50-53

FIXED

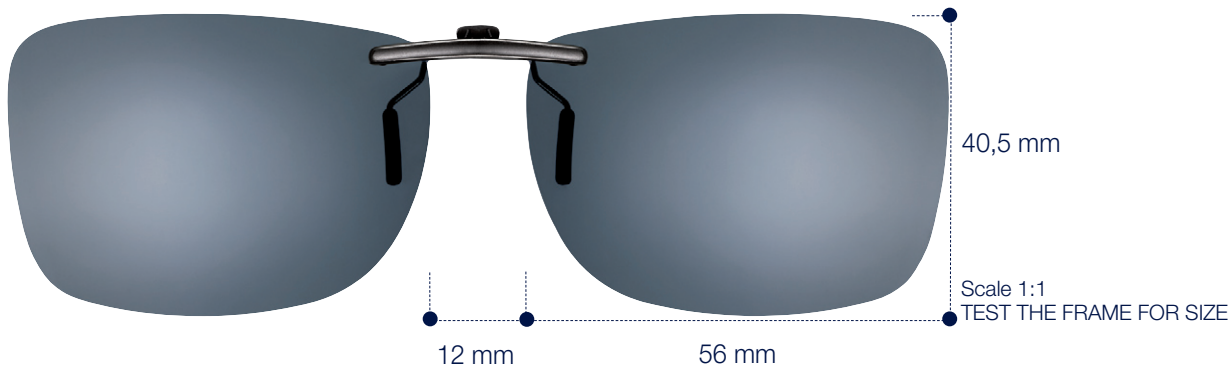

Polarized Lenses 100% UVA-UVB protection up to 390 nm | Filter Category 3 | CE



Grey

Ref. 12780



G15

Ref. 12781



Brown

Ref. 12782



Yellow FC0 polarized

Ref. 12797



Brown/Red Mirror

Ref. 12885



Case included.



■ FOR PLASTIC FRAMES

- Trimmable Lenses
- Anti-scratch hooks
- Case included

FOR FRAME - SIZE 53-55

FIXED



Polarized Lenses 100% UVA-UVB protection up to 390 nm | Filter Category 3 | CE



Smoke

Ref. C0274 58 019 001



G15

Ref. C0274 58 019 002



Brown

Ref. C0274 58 019 003

1 pc.

CE SPECIFICATIONS
IN ACCORDANCE WITH
REGULATION (UE) 2016/425

Case included.



■ FOR PLASTIC FRAMES

- Trimmable Lenses
- Anti-scratch hooks
- Case included

FOR FRAME - SIZE 52-54

FIXED

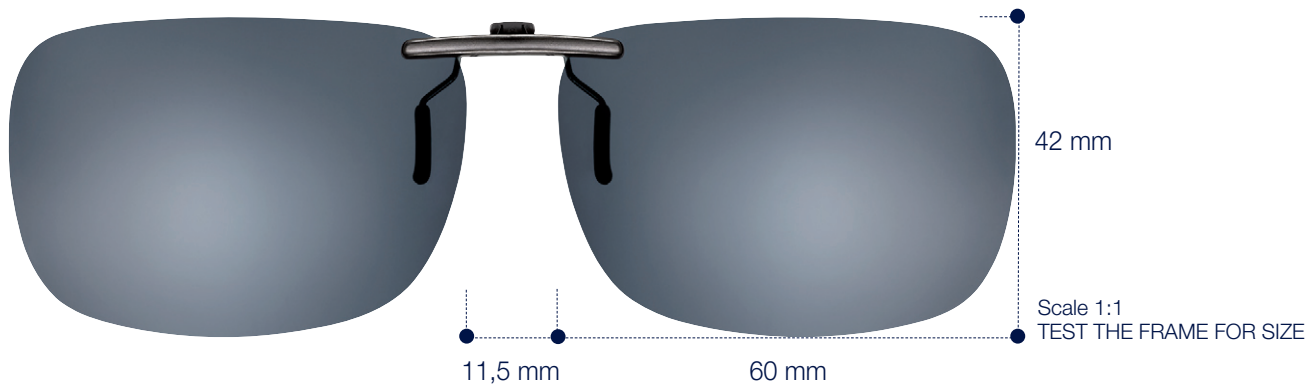

Polarized Lenses 100% UVA-UVB protection up to 390 nm | Filter Category 3 | CE



Grey
Ref. 12783



G15
Ref. 12784



Brown
Ref. 12785

 1 pc.

Case included.



■ FOR PLASTIC FRAMES

- Trimmable Lenses
- Anti-scratch hooks
- Case included

FOR FRAME - SIZE 51-55

FIXED

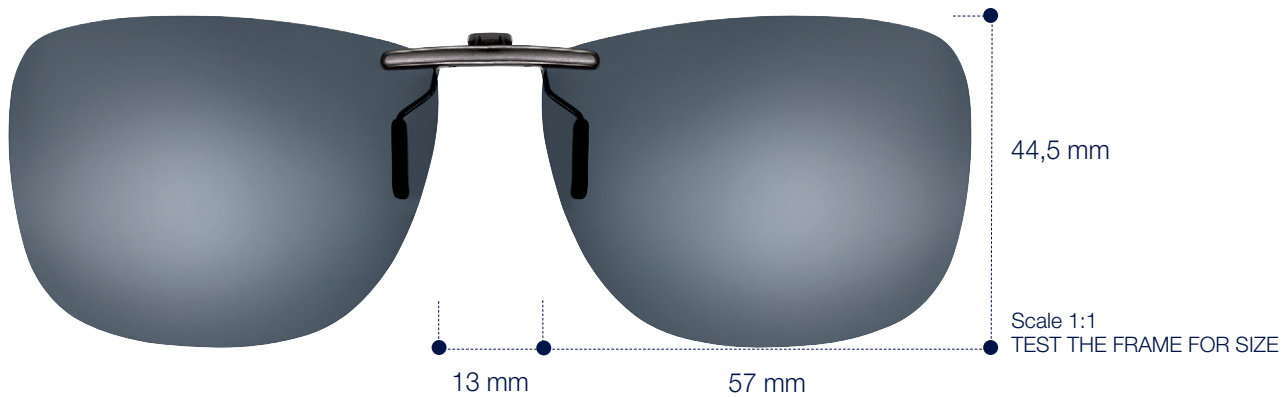

Polarized Lenses 100% UVA-UVB protection up to 390 nm | Filter Category 3 | **CE**



Grey

Ref. 12786



G15

Ref. 12787



Brown

Ref. 12788

1 pc.

CE SPECIFICATIONS
IN ACCORDANCE WITH
REGULATION (UE) 2016/425

Case included.



■ FOR PLASTIC FRAMES

- Trimmable Lenses
- Anti-scratch hooks
- Case included

FOR FRAME - SIZE 50-53

FIXED



Polarized Lenses 100% UVA-UVB protection up to 390 nm | Filter Category 3 | **CE**



Grey
Ref. 12789



G15
Ref. 12790



Brown
Ref. 12791

 1 pc.



G15/Yellow Mirror
Ref. 12887  1 pc.

Case included.



■ FOR PLASTIC FRAMES

- Trimmable Lenses
- Anti-scratch hooks
- Case included

FOR FRAME - SIZE 56-58

FIXED



Polarized Lenses 100% UVA-UVB protection up to 390 nm | Filter Category 3 | **CE**



Grey
Ref. 12765



G15
Ref. 12766



Brown
Ref. 12767

1 pc.

CE SPECIFICATIONS
IN ACCORDANCE WITH
REGULATION (UE) 2016/425

Case included.



■ FOR RIMLESS FRAMES

- Trimmable Lenses
- Anti-scratch hooks
- Case included

FOR RIMLESS FRAMES WITH LOW CURVATURE LENSES SIZE 50-52

(The clip-on must not touch the lens in the centre)



Polarized Lenses 100% UVA-UVB protection up to 390 nm | Filter Category 3 | CE



Grey
Ref. 12768



G15
Ref. 12769



Brown
Ref. 12770

 1 pc.

Case included.



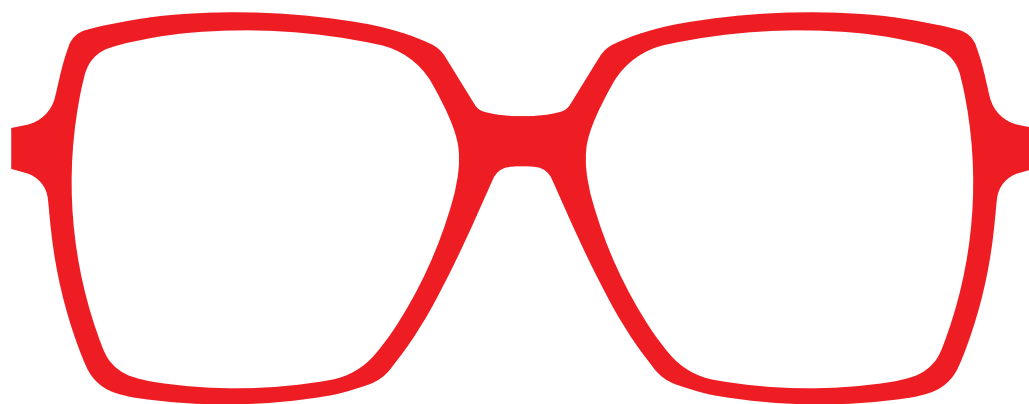

Fixed Clip-On

Suitable for

WIDE SQUARE shapes

■ FOR PLASTIC FRAMES

- Trimmable Lenses
- Anti-scratch hooks
- Case included

FOR FRAME - SIZE 53-55

FIXED



Polarized Lenses 100% UVA-UVB protection up to 390 nm | Filter Category 3 | **CE**



Smoke

Ref. C0353 59 019 001



G15

Ref. C0353 59 019 002



Brown

Ref. C0353 59 019 003

1 pc.

CE SPECIFICATIONS
IN ACCORDANCE WITH
REGULATION (UE) 2016/425

Case included.



■ FOR PLASTIC FRAMES

- Trimmable Lenses
- Anti-scratch hooks
- Case included

FOR FRAME - SIZE 55-57

FIXED



Polarized Lenses 100% UVA-UVB protection up to 390 nm | Filter Category 3 | **CE**



Smoke

Ref. C0273 62 019 001



G15

Ref. C0273 62 019 002



Brown

Ref. C0273 62 019 003

1 pc.

CE SPECIFICATIONS
IN ACCORDANCE WITH
REGULATION (UE) 2016/425

Case included.







CLIP-ON TRIMMABLE/FIXED

Clip-ons with minimal mechanism, **trimmable lenses** and anti-scratch clips. Easy to put on and take off by pressing the central spring. **Polarized lenses** for **maximum protection against UVA and UVB rays.**

■ FOR PLASTIC FRAMES

- Trimmable Lenses
- Anti-scratch hooks
- Case included

Polarized Lenses 100% UVA-UVB protection up to 390 nm | Filter Category 3 | **CE**

FIXED

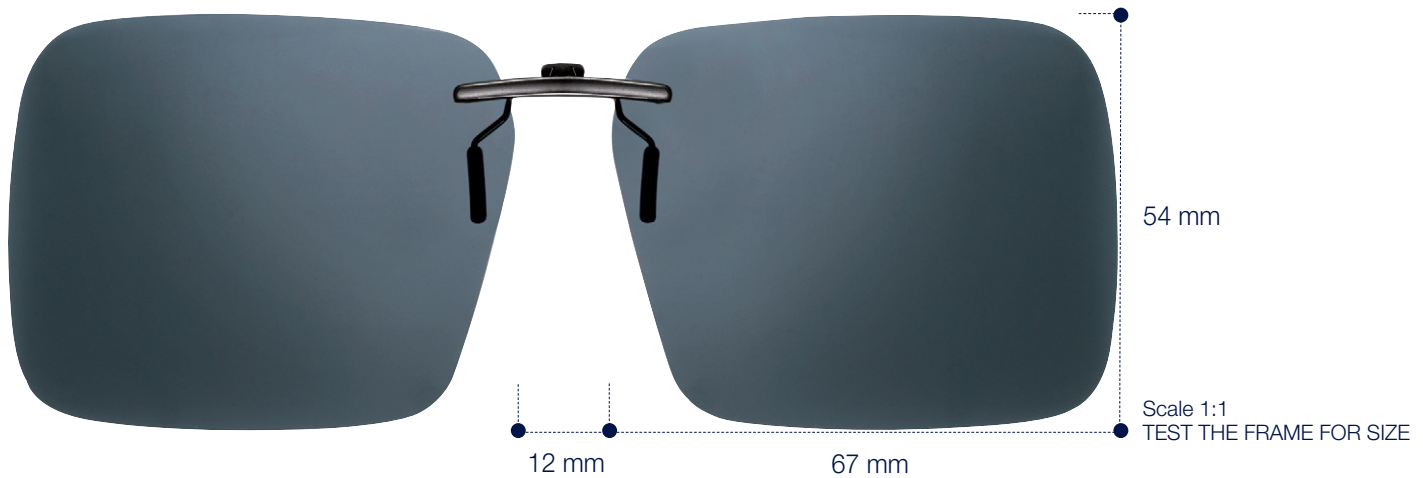

Grey

Ref. 12774



G15

Ref. 12775



Brown

Ref. 12776

 1 pc.



Yellow FC0 polarized

Ref. 12799

 1 pc.

CE SPECIFICATIONS
IN ACCORDANCE WITH
REGULATION (UE) 2016/425

Case included.



FOR PLASTIC FRAMES

NEW

- Trimmable Lenses
- Anti-scratch hooks
- Case included

Polarized Lenses 100% UVA-UVB protection up to 390 nm | Filter Category 3 | CE

FIXED

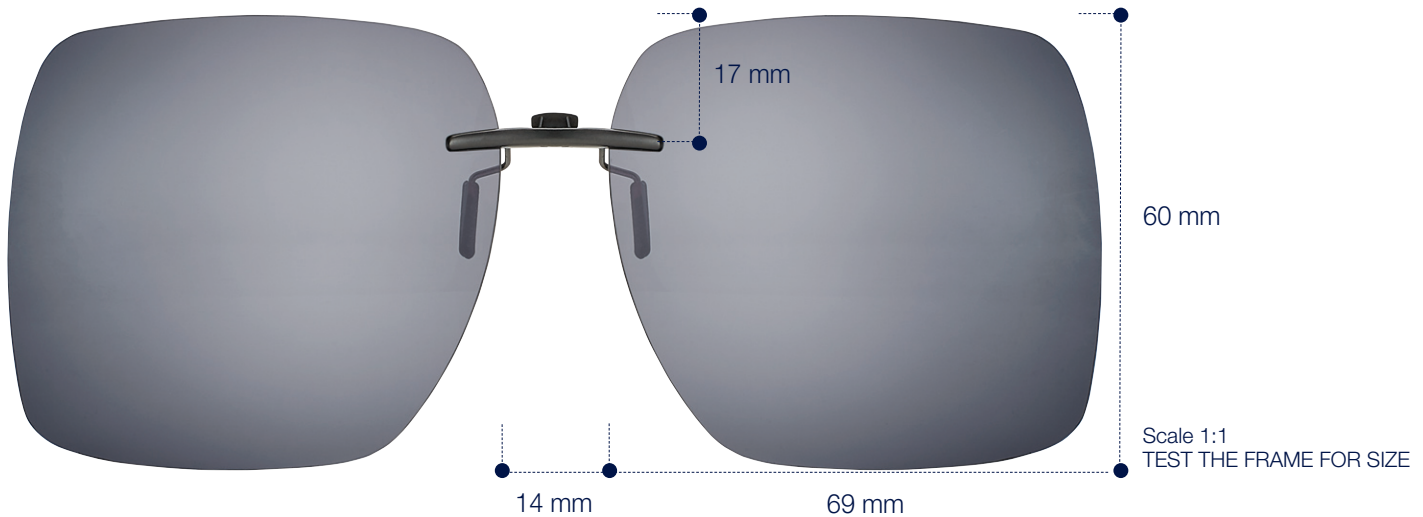

Grey

Ref. C0523 69 019 001



G15

Ref. C0523 69 019 002

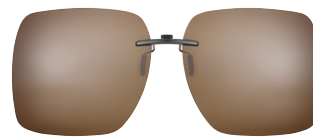

Brown

Ref. C0523 69 019 003

1 pc.

CE SPECIFICATIONS
IN ACCORDANCE WITH
REGULATION (UE) 2016/425

Case included.



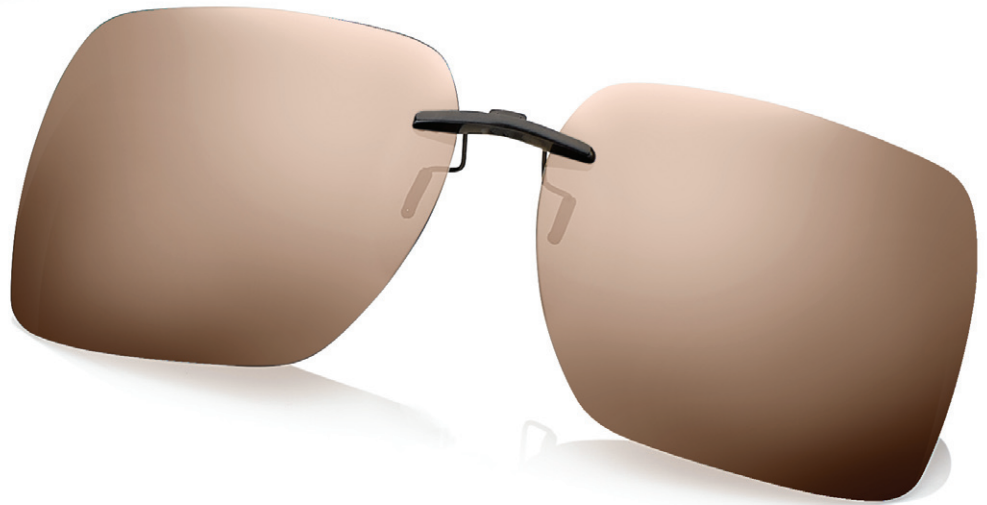

FOR METAL FRAMES

Ref. CK0002

Kit of 12 clip-on of your choice
Minimal mechanism for **metal frame**.



Ref. 11277

Only Couvette



FIXED CLIP-ON WITH MINIMAL MECHANISM

FOR **METAL**
FRAMES



Advice for correct use:

- Do not use force
- Do not try to flip them up

1.

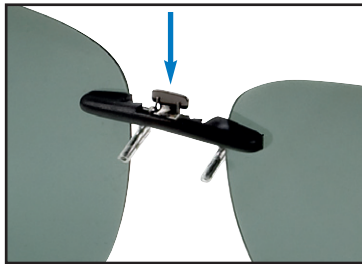

2.

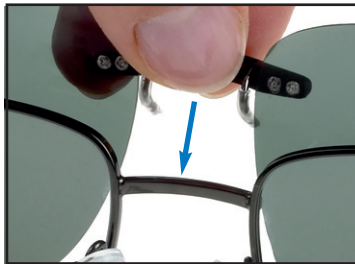

3.

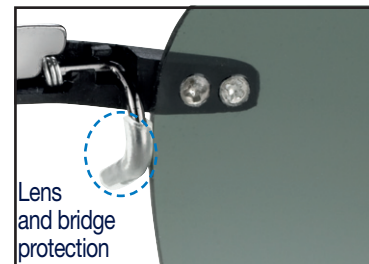

Backing card with technical data and indication of size.

Test the frame for size.

CLIP-ON

for **METAL** frames

58

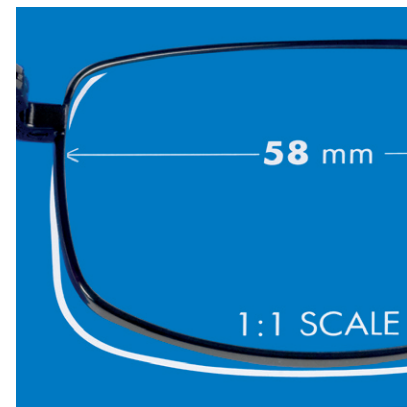
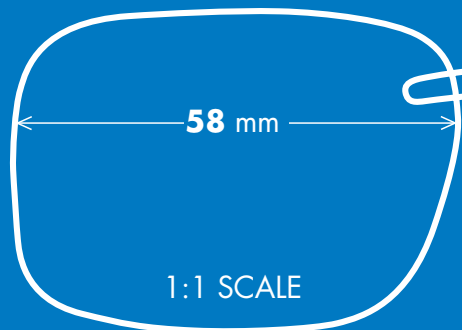

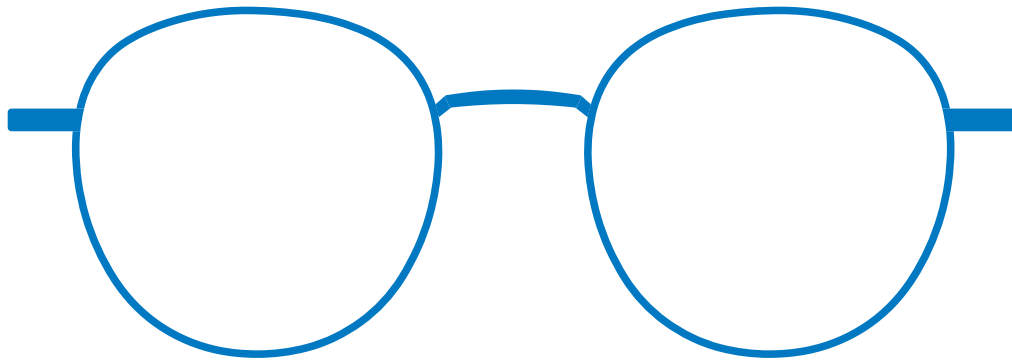

Fixed Clip-On

Suitable for

PANTHOS shapes



FOR METAL FRAMES

- Trimmable Lenses
- Anti-scratch hooks
- Case included

FOR FRAME - SIZE 48-50

FIXED



Polarized Lenses 100% UVA-UVB protection up to 390 nm | Filter Category 3 | CE



Grey

Ref. C0352 53 019 001



G15

Ref. C0352 53 019 002



Brown

Ref. C0352 53 019 003

 1 pc.

CE SPECIFICATIONS
IN ACCORDANCE WITH
REGULATION (UE) 2016/425

Case included.



■ FOR METAL FRAMES

- Trimmable Lenses
- Anti-scratch hooks
- Case included

FOR FRAME - SIZE 49-53

FIXED

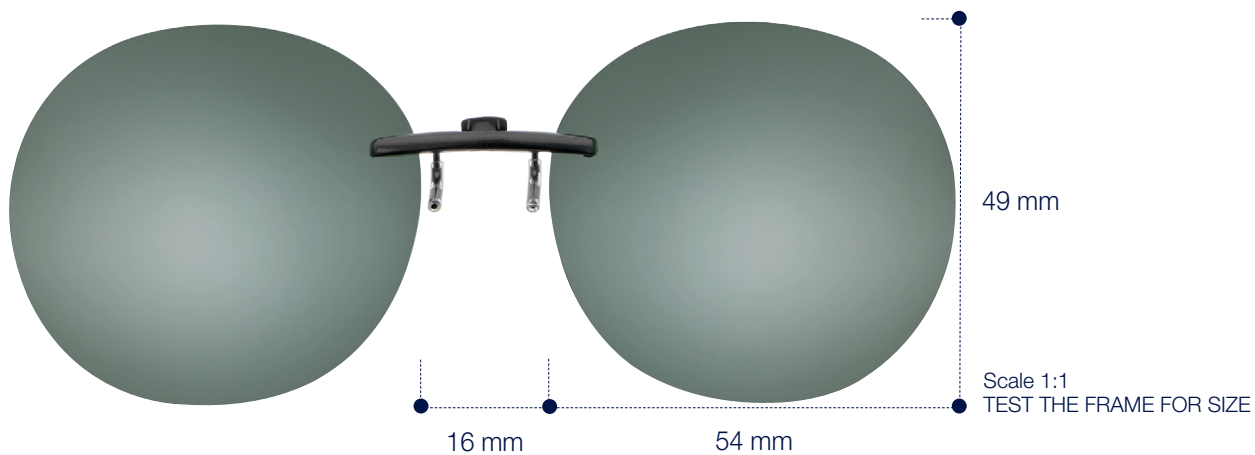

Polarized Lenses 100% UVA-UVB protection up to 390 nm | Filter Category 3 | CE



Grey

Ref. C0096 54 019 001



G15

Ref. C0096 54 019 002

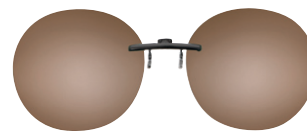

Brown

Ref. C0096 54 019 003

 1 pc.

Case included.



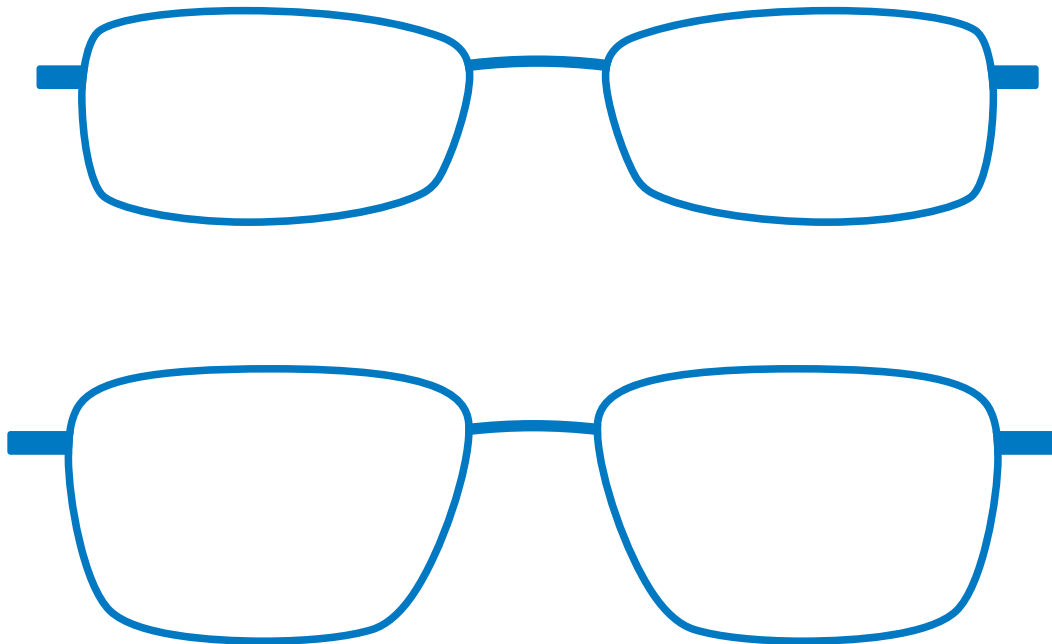

Fixed Clip-On

Suitable for

RECTANGULAR shapes



■ FOR METAL FRAMES

- Trimmable Lenses
- Anti-scratch hooks
- Case included

FOR FRAME - SIZE 49-51

FIXED



Polarized Lenses 100% UVA-UVB protection up to 390 nm | Filter Category 3 | CE



G15

Ref. 12795



Brown

Ref. 12796

 1 pc.

CE SPECIFICATIONS
IN ACCORDANCE WITH
REGULATION (UE) 2016/425

Case included.



■ FOR METAL FRAMES

- Trimmable Lenses
- Anti-scratch hooks
- Case included

FOR FRAME - SIZE 50-53

FIXED



Polarized Lenses 100% UVA-UVB protection up to 390 nm | Filter Category 3 | CE



Grey
Ref. 12756

1 pc.



G15
Ref. 12757

1 pc.



Brown
Ref. 12758

1 pc.



Yellow FC0 polarized
Ref. 12805

1 pc.

Case included.



■ FOR METAL FRAMES

- Trimmable Lenses
- Anti-scratch hooks
- Case included

FOR FRAME - SIZE 52-55

FIXED



Polarized Lenses 100% UVA-UVB protection up to 390 nm | Filter Category 3 | **CE**



Grey

Ref. 12753



G15

Ref. 12754



Brown

Ref. 12755

 1 pc.



Yellow FC0 polarized

Ref. 12798

 1 pc.

CE SPECIFICATIONS
IN ACCORDANCE WITH
REGULATION (UE) 2016/425

Case included.



■ FOR METAL FRAMES

- Trimmable Lenses
- Anti-scratch hooks
- Case included

FOR FRAME - SIZE 52-55

FIXED

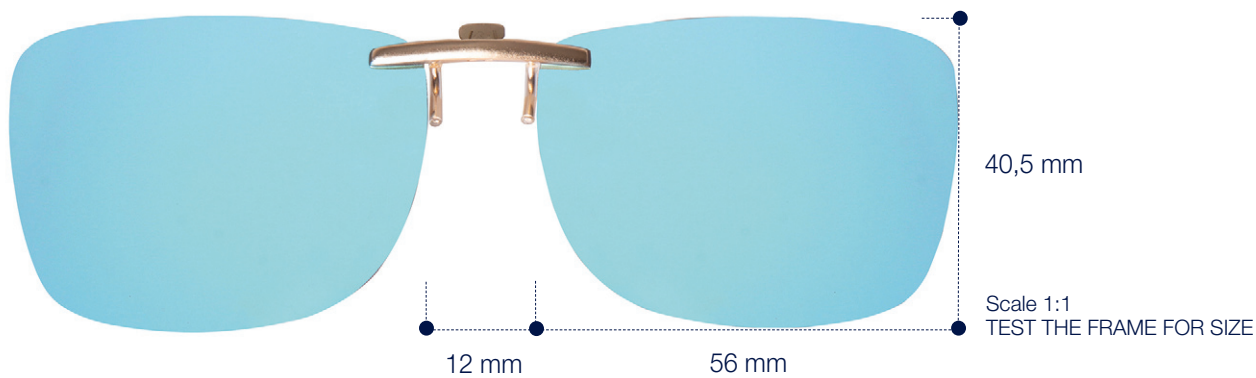

Polarized Lenses 100% UVA-UVB protection up to 390 nm | Filter Category 3 | CE



Brown/Light Blue Mirror

Ref. 12812

 1 pc.

Case included.



■ FOR METAL FRAMES

- Trimmable Lenses
- Anti-scratch hooks
- Case included

FOR FRAME - SIZE 52-55

FIXED

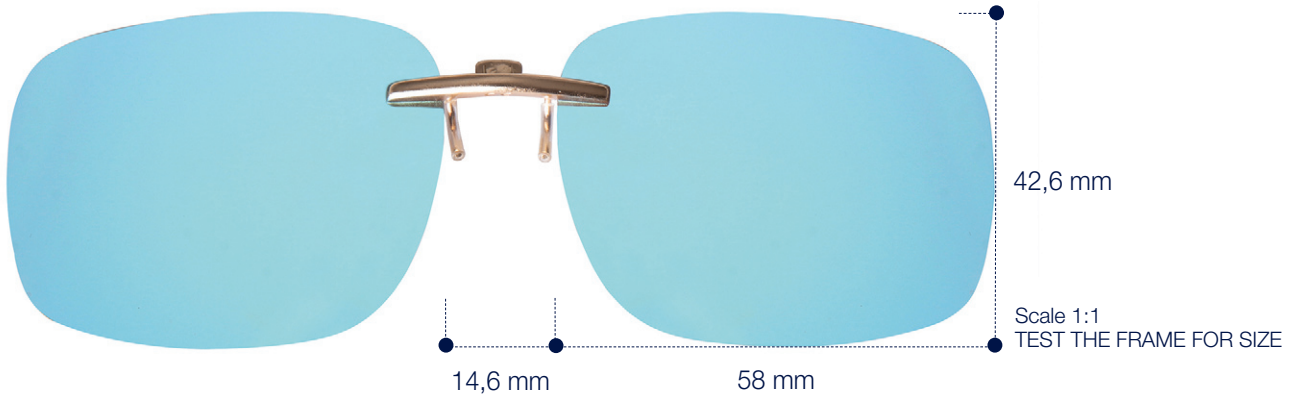

Polarized Lenses 100% UVA-UVB protection up to 390 nm | Filter Category 3 | **CE**



Ref. 12802

 1 pc.

CE SPECIFICATIONS
IN ACCORDANCE WITH
REGULATION (UE) 2016/425

Case included.



FOR METAL FRAMES

- Trimmable Lenses
- Anti-scratch hooks
- Case included

FOR FRAME - SIZE 52-55

FIXED

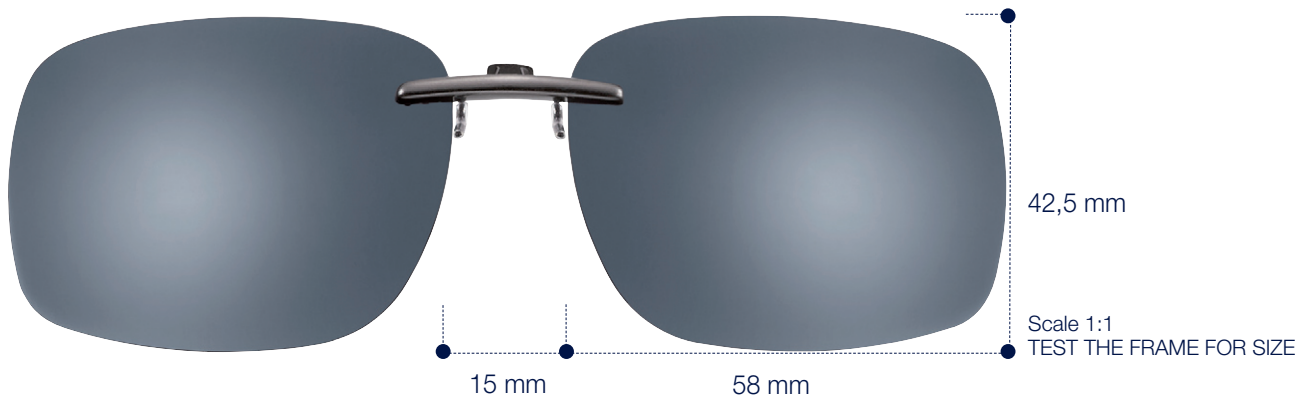

Polarized Lenses 100% UVA-UVB protection up to 390 nm | Filter Category 3 | CE



Grey

Ref. 12750



G15

Ref. 12751



Brown

Ref. 12752

1 pc.



G15/Yellow Mirror

Ref. 12881

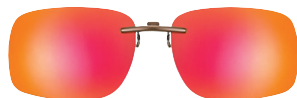

Brown/Red Mirror

Ref. 12882



Yellow FC0 polarized

Ref. 12806

1 pc.

Case included.



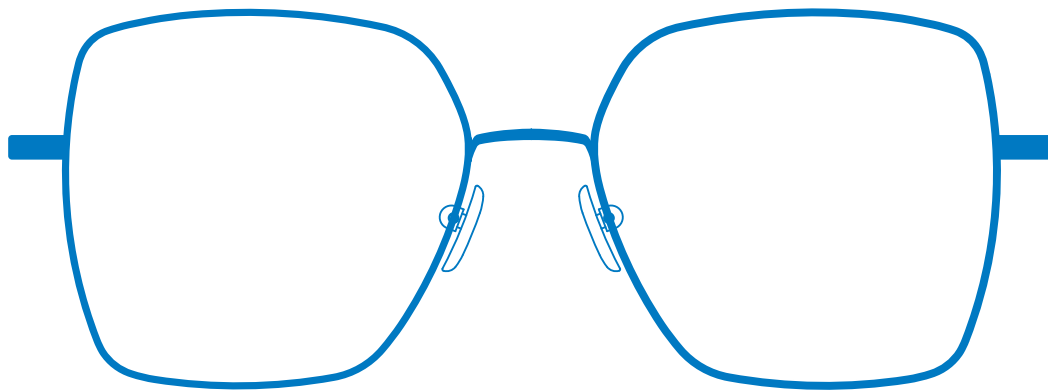

Fixed Clip-On

Suitable for

WIDE SQUARE shapes

■ FOR METAL FRAMES

- Trimmable Lenses
- Anti-scratch hooks
- Case included

FOR FRAME - SIZE 53-55

FIXED



Polarized Lenses 100% UVA-UVB protection up to 390 nm | Filter Category 3 | **CE**



Smoke

Ref. C0271 60 019 001



G15

Ref. C0271 60 019 002



Brown

Ref. C0271 60 019 003

1 pc.

CE SPECIFICATIONS
IN ACCORDANCE WITH
REGULATION (UE) 2016/425

Case included.



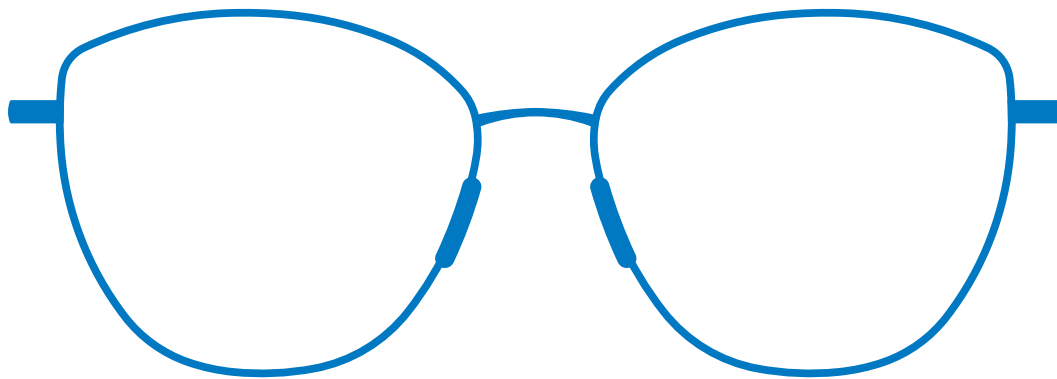

Fixed Clip-On

Suitable for

CAT-EYE shapes

■ FOR METAL FRAMES

- Trimmable Lenses
- Anti-scratch hooks
- Case included

FOR FRAME - SIZE 53-55

FIXED

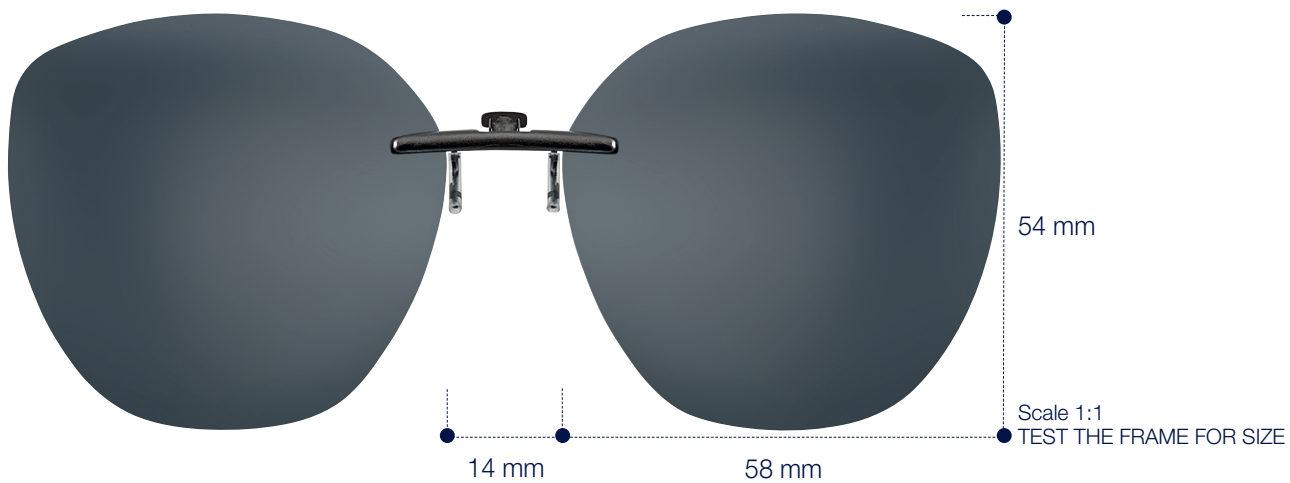

Polarized Lenses 100% UVA-UVB protection up to 390 nm | Filter Category 3 | **CE**



Smoke

Ref. C0272 58 019 001



G15

Ref. C0272 58 019 002



Brown

Ref. C0272 58 019 003

1 pc.

CE SPECIFICATIONS
IN ACCORDANCE WITH
REGULATION (UE) 2016/425

Case included.





CLIP-ON TRIMMABLE/FIXED

Clip-ons with **trimmable lenses** and **anti-scratch hooks**. **Polarized lenses** for maximum UVA-UVB protection. **Ideal for any shape of frames.**

FOR METAL FRAMES

- Trimmable Lenses
- Anti-scratch hooks
- Case included

Polarized Lenses 100% UVA-UVB protection up to 390 nm | Filter Category 3 | CE

FIXED

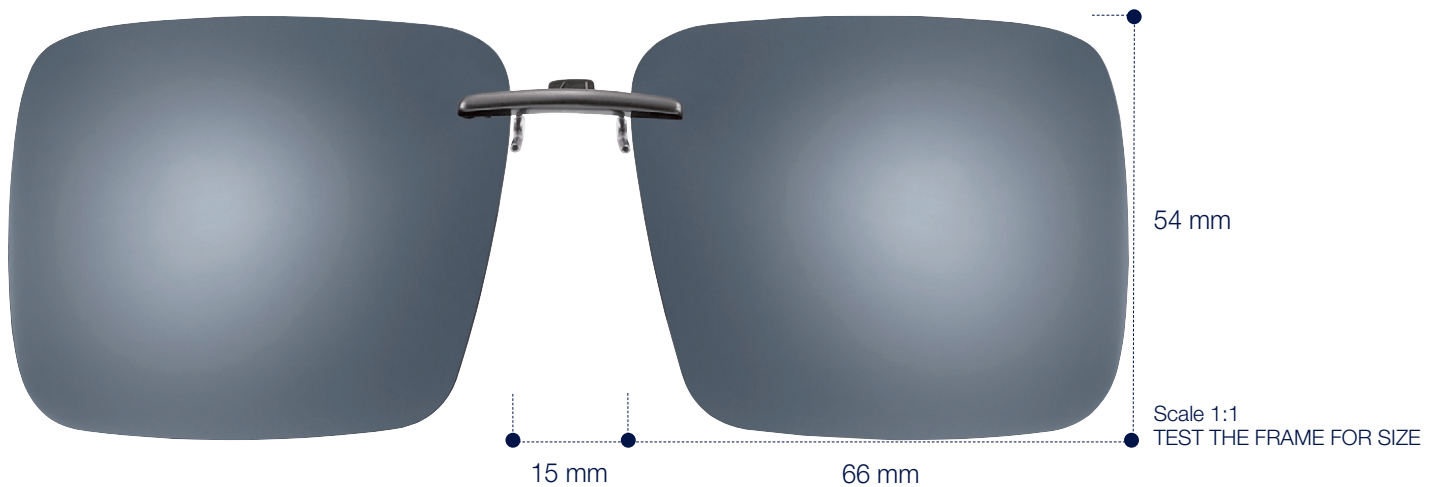

Grey

Ref. 12759



G15

Ref. 12760

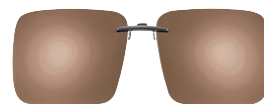

Brown

Ref. 12761

 1 pc.



Yellow FC0 polarized

Ref. 12807

 1 pc.

Case included.





CLIP-ON TRIMMABLE/FLIP-UPS

Flip-Ups with **minimal mechanism**.

Easy to put on and take off by **pressing the central spring**.

Polarized lenses for maximum protection against UVA and UVB rays.



FOR ALL KIND OF FRAMES

Ref. CK0003

Kit of 12 clip-on of your choice

Minimal mechanism for **plastic** and **metal** frame.



Ref. 11277

Only Couvette



CLIP-ON FLIP-UPS WITH MINIMAL MECHANISM

FOR **PLASTIC** AND **METAL**
FRAMES

**Only one advice
for correct use:**

- Do not use force

Ref. 12534RG

Spare rubber tips for classic Flip-Ups
10 pcs.



1.

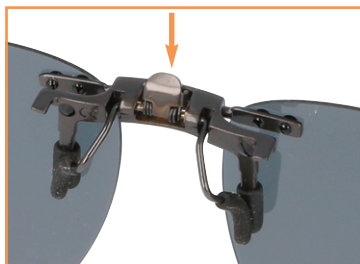

2.

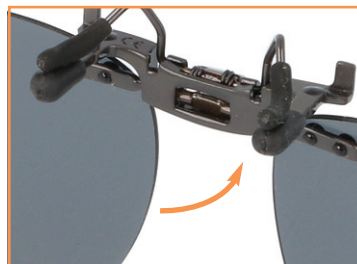

3.

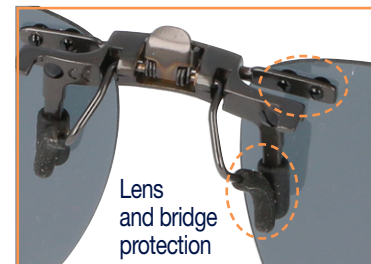

Backing card with technical data and indication of size.

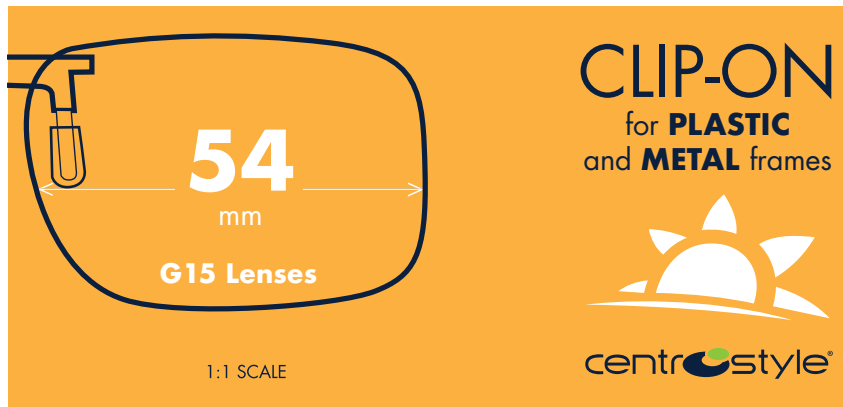

Test the frame for size.



FOR PLASTIC AND METAL FRAMES

- Trimmable Lenses
- Anti-scratch hooks
- Case included

FOR FRAME - SIZE 49-53

FLIP-UPS



Polarized Lenses 100% UVA-UVB protection up to 390 nm | Filter Category 3 | CE



Grey
Ref. C0061 56 019 001



G15
Ref. C0061 56 019 002



Brown
Ref. C0061 56 019 003



Brown/Light Blue Mirror
Ref. C0061 56 019 008



Grey/Silver Mirror
Ref. C0061 56 019 024

1 pc.

CE SPECIFICATIONS
IN ACCORDANCE WITH
REGULATION (UE) 2016/425

Case included.



FOR PLASTIC AND METAL FRAMES

- Trimmable Lenses
- Anti-scratch hooks
- Case included

Polarized Lenses 100% UVA-UVB protection up to 390 nm | Filter Category 3 | CE

FLIP-UPS



Brown

Ref. C0062 60 019 003



Grey

Ref. C0062 60 019 001



G15

Ref. C0062 60 019 002

1 pc.

Case included.



Ref. 03916

Clip-on or triacetate filters (TAC) shaping kit composed of:

- Special marker pen (Ref. 06965)
- Stainless steel scissors (Ref. 03781)
- Flat needle file (Ref. 02908)
- Scalpel knife (Ref. 03785)
- Tray included, suitable for new LMS Cube.

VIDEO



FOR PLASTIC AND METAL FRAMES

- Trimmable Lenses
- Anti-scratch hooks
- Case included

FOR FRAME - SIZE 50-53

FLIP-UPS

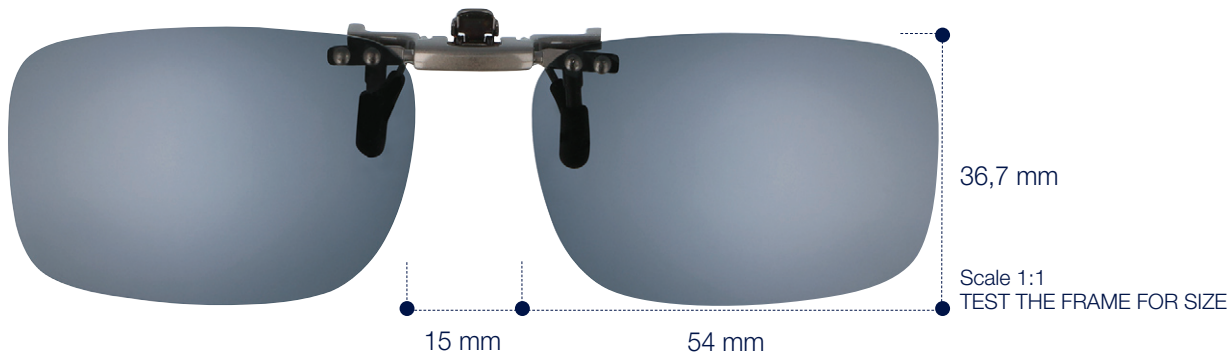

Polarized Lenses 100% UVA-UVB protection up to 390 nm | Filter Category 3 | **CE**



Grey
Ref. 12723



G15
Ref. 12724



Brown
Ref. 12725

 1 pc.

CE SPECIFICATIONS
IN ACCORDANCE WITH
REGULATION (UE) 2016/425

Case included.



FOR PLASTIC AND METAL FRAMES

- Trimmable Lenses
- Anti-scratch hooks
- Case included

FOR FRAME - SIZE 52-54

FLIP-UPS



Polarized Lenses 100% UVA-UVB protection up to 390 nm | Filter Category 3 | CE



Grey

Ref. 12726



G15

Ref. 12727



Brown

Ref. 12728

1 pc.

Case included.



Ref. 03916

Clip-on or triacetate filters (TAC) shaping kit composed of:

Special marker pen (Ref. 06965)

Stainless steel scissors (Ref. 03781)

Flat needle file (Ref. 02908)

Scalpel knife (Ref. 03785)

Tray included, suitable for new LMS Cube.

VIDEO



FOR PLASTIC AND METAL FRAMES

- Trimmable Lenses
- Anti-scratch hooks
- Case included

FOR FRAME - SIZE 54-56

FLIP-UPS

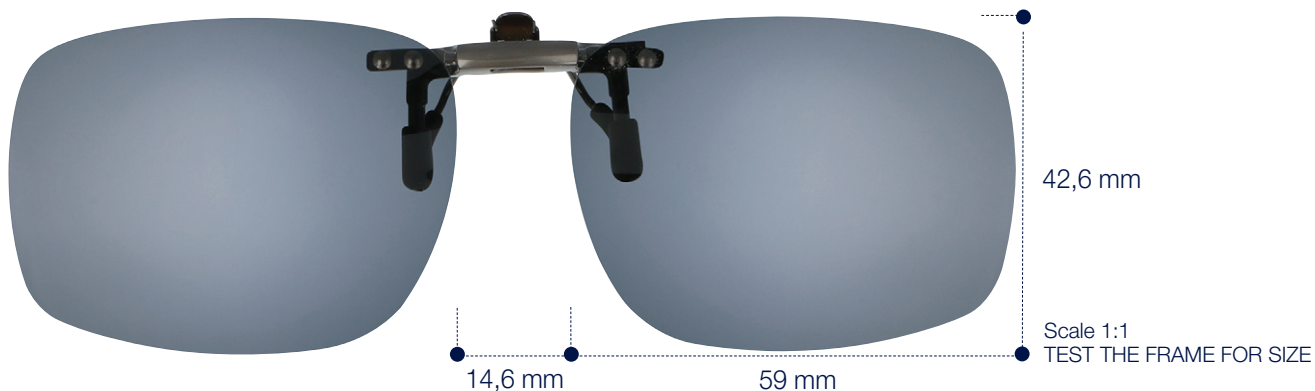

Polarized Lenses 100% UVA-UVB protection up to 390 nm | Filter Category 3 | CE



Grey
Ref. 12733



G15
Ref. 12734



Brown
Ref. 12735



Grey/Silver Mirror
Ref. 12848



Brown/Light Blue Mirror
Ref. 12847

1 pc.

CE SPECIFICATIONS
IN ACCORDANCE WITH
REGULATION (UE) 2016/425

Case included.



FOR PLASTIC AND METAL FRAMES

- Trimmable Lenses
- Anti-scratch hooks
- Case included

Polarized Lenses 100% UVA-UVB protection up to 390 nm | Filter Category 3 | CE

FLIP-UPS

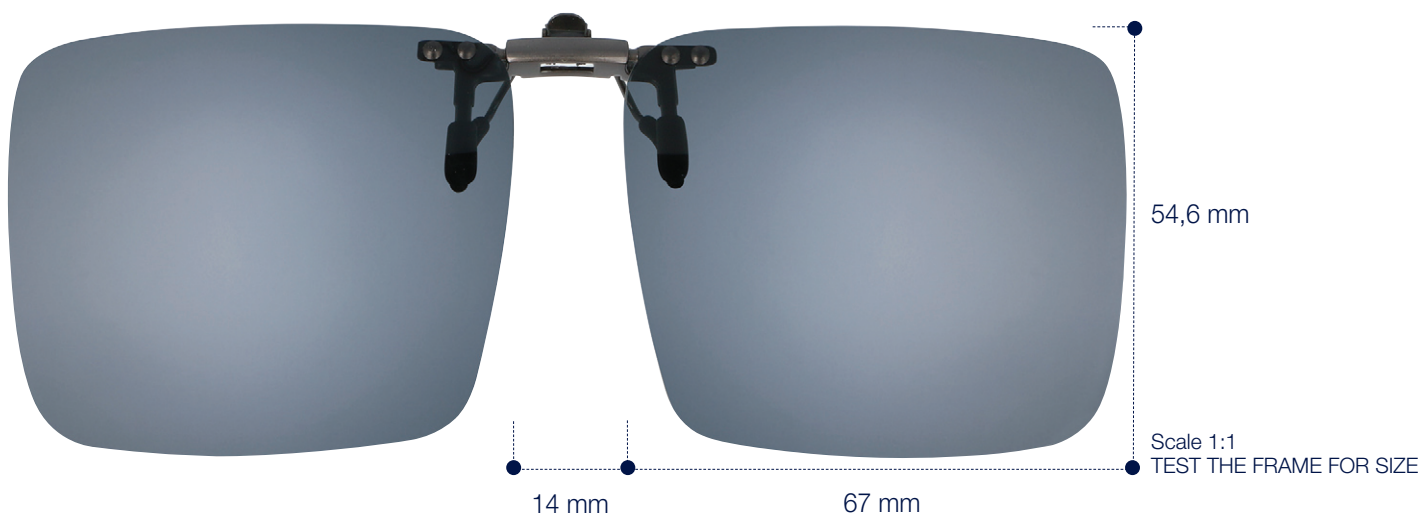

Grey

Ref. 12736

1 pc.



G15

Ref. 12737

1 pc.



Brown

Ref. 12738

1 pc.



Yellow FC0 polarized

Ref. 12808

1 pc.



Blue Light FC0 no polarized

Ref. 12736BL

1 pc.

Ref. 03916

Clip-on or triacetate filters (TAC) shaping kit composed of:

Special marker pen (Ref. 06965)

Stainless steel scissors (Ref. 03781)

Flat needle file (Ref. 02908)

Scalpel knife (Ref. 03785)

Tray included, suitable for new LMS Cube.



VIDEO



FOR PLASTIC AND METAL FRAMES

- Trimmable Lenses
- Anti-scratch hooks
- Case included

Polarized Lenses 100% UVA-UVB protection up to 390 nm | Filter Category 3 | CE

FLIP-UPS

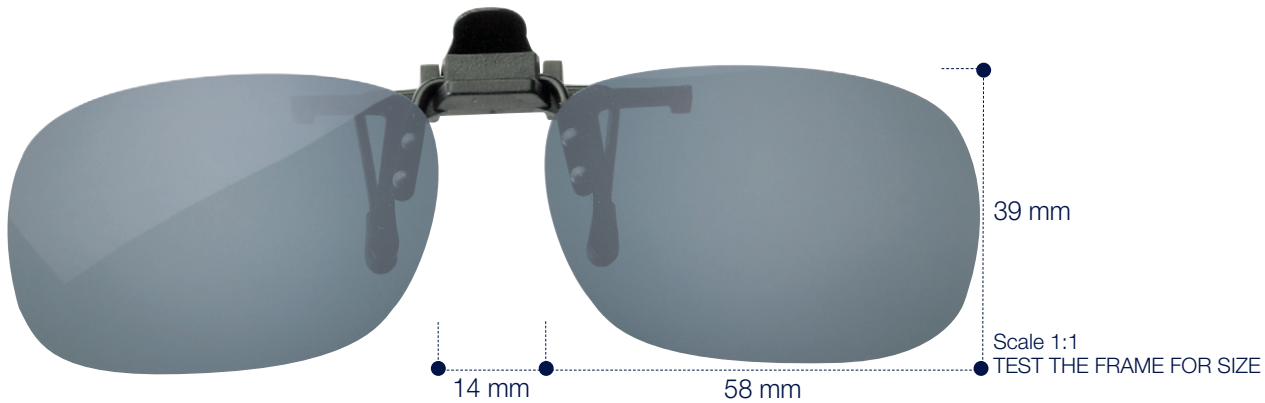

Grey

Ref. 12535



Brown

Ref. 12534

 1 pc.

CE SPECIFICATIONS
IN ACCORDANCE WITH
REGULATION (UE) 2016/425

Case included.



FOR PLASTIC AND METAL FRAMES

- Trimmable Lenses
- Anti-scratch hooks
- Case included

Polarized Lenses 100% UVA-UVB protection up to 390 nm | Filter Category 3 | CE

FLIP-UPS

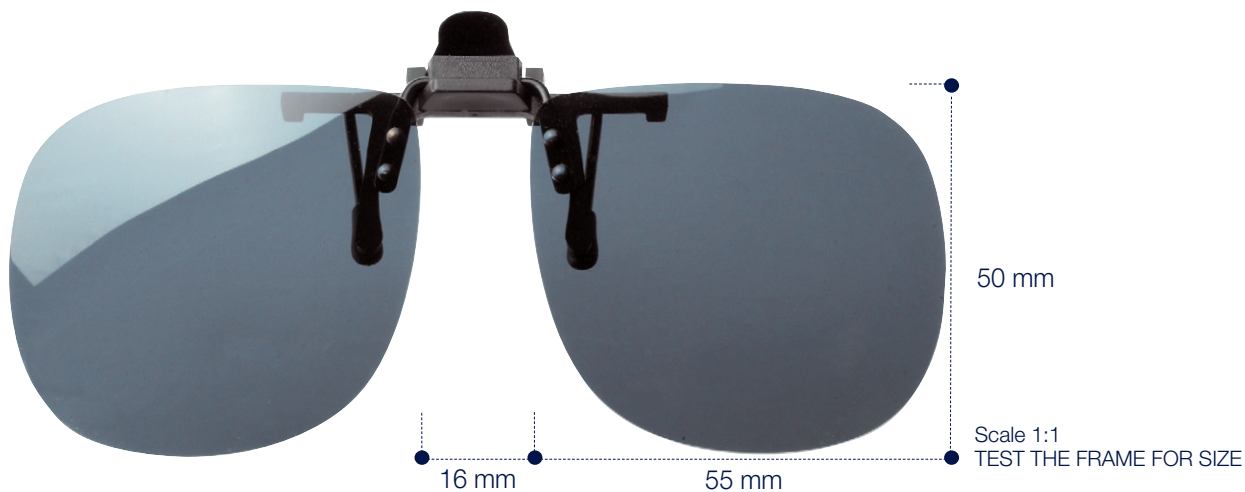

Grey

Ref. 12653



Brown

Ref. 12652

6 pcs.

Ref. 03916

Clip-on or triacetate filters (TAC) shaping kit composed of:

- Special marker pen (Ref. 06965)
- Stainless steel scissors (Ref. 03781)
- Flat needle file (Ref. 02908)
- Scalpel knife (Ref. 03785)
- Tray included, suitable for new LMS Cube.

VIDEO



Case included.



FOR PLASTIC AND METAL FRAMES

- Trimmable Lenses
- Anti-scratch hooks
- Case included

Polarized Lenses 100% UVA-UVB protection up to 390 nm | Filter Category 3 | **CE**

FLIP-UPS

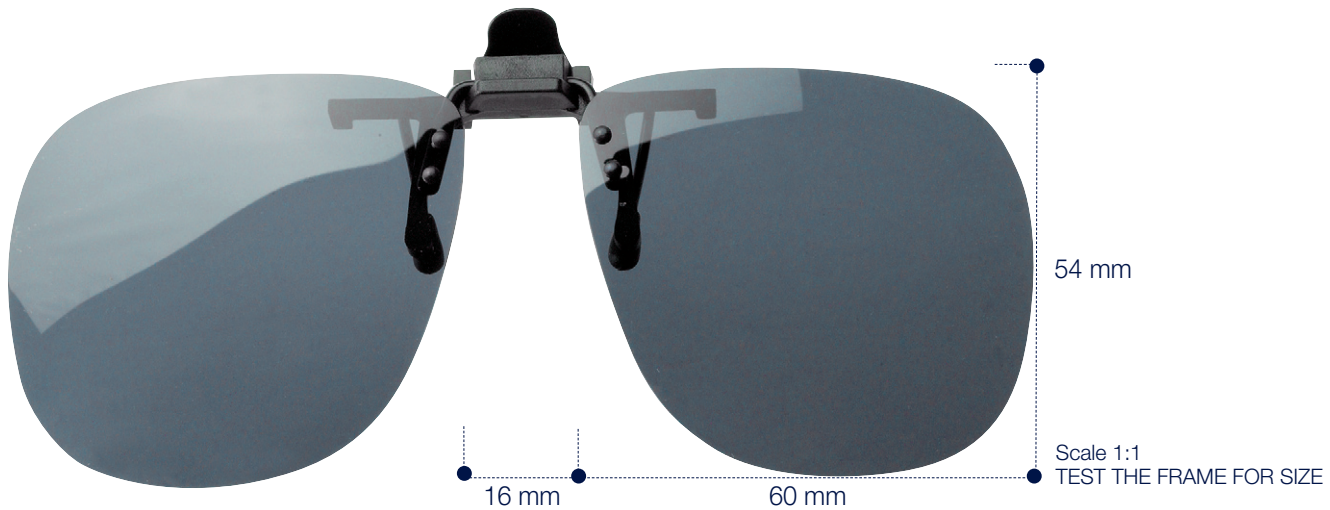

Grey

Ref. 12651



Brown

Ref. 12650

 6 pcs.

CE SPECIFICATIONS
IN ACCORDANCE WITH
REGULATION (UE) 2016/425

Case included.



FOR PLASTIC AND METAL FRAMES

- Trimmable Lenses
- Anti-scratch hooks
- Case included

Polarized Lenses 100% UVA-UVB protection up to 390 nm | Filter Category 3 | CE

FLIP-UPS

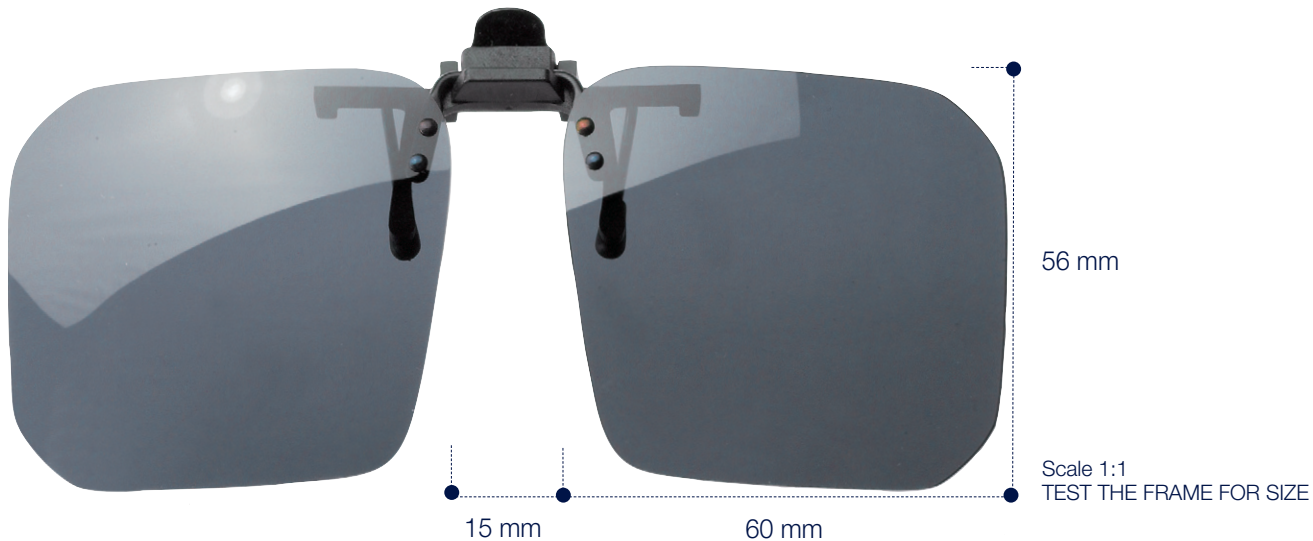

Grey

Ref. 12558



Brown

Ref. 12557

 6 pcs.

Ref. 03916

Clip-on or triacetate filters (TAC) shaping kit composed of:

- Special marker pen (Ref. 06965)
- Stainless steel scissors (Ref. 03781)
- Flat needle file (Ref. 02908)
- Scalpel knife (Ref. 03785)
- Tray included, suitable for new LMS Cube.

VIDEO



Case included.





METAL RIM CLIP-ONS

Clip-Ons with **anti-scratch clips**.

Polarized lenses for maximum protection against
UVA and UVB rays.



FOR PLASTIC AND METAL FRAMES

- Trimmable Lenses
- Anti-scratch hooks
- Case included

Polarized Lenses 100% UVA-UVB protection up to 390 nm | Filter Category 3 | **CE**

FIXED

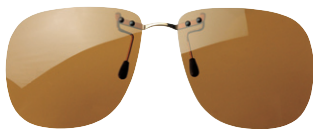
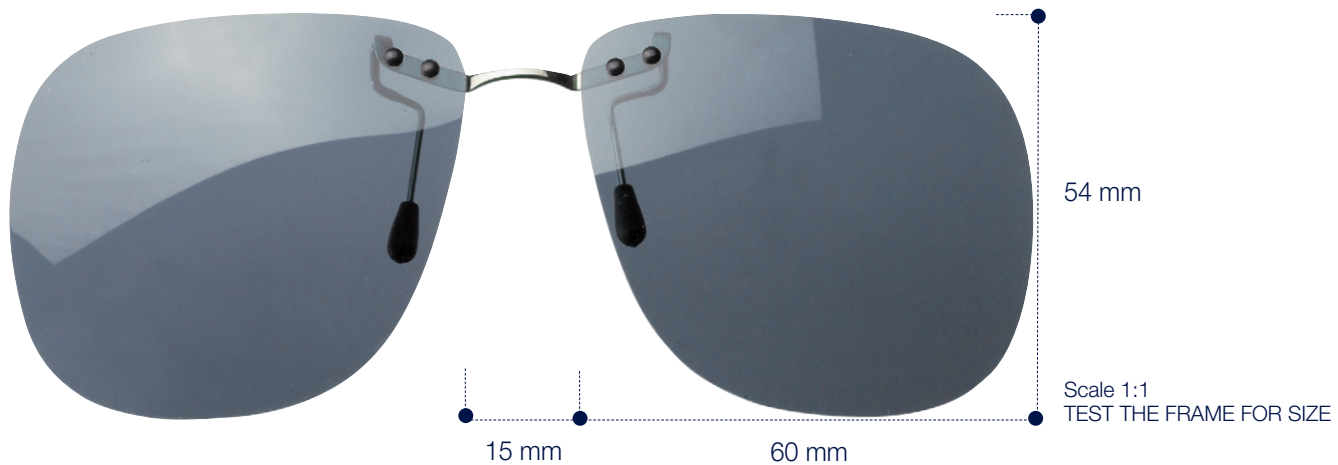

Brown

Ref. 12612



Grey

Ref. 12613

 6 pcs.

CE SPECIFICATIONS
IN ACCORDANCE WITH
REGULATION (UE) 2016/425

Case included.



FOR PLASTIC AND METAL FRAMES

- Trimmable Lenses
- Anti-scratch hooks
- Case included

Polarized Lenses 100% UVA-UVB protection up to 390 nm | Filter Category 3 | CE

FIXED

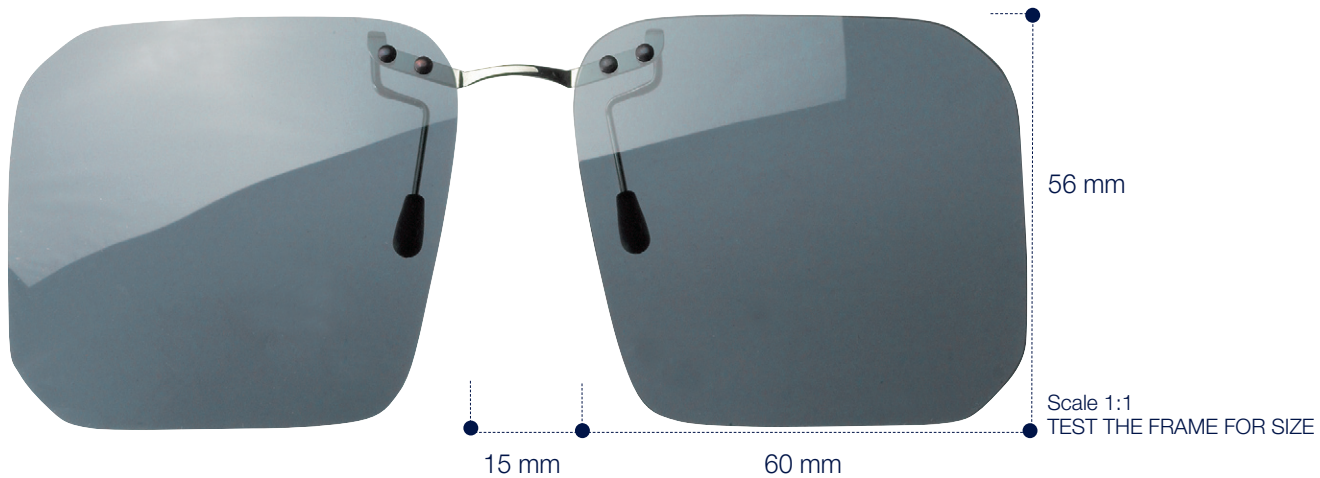

Grey

Ref. 12517

 6 pcs.

Case included.





FOR PLASTIC AND METAL FRAMES

- Anti-scratch hooks
- Case included
- Flexible bridge
- Ideal for Sized 4 You Ref. **F0303 46**

FOR FRAME - SIZE 46-48

FIXED

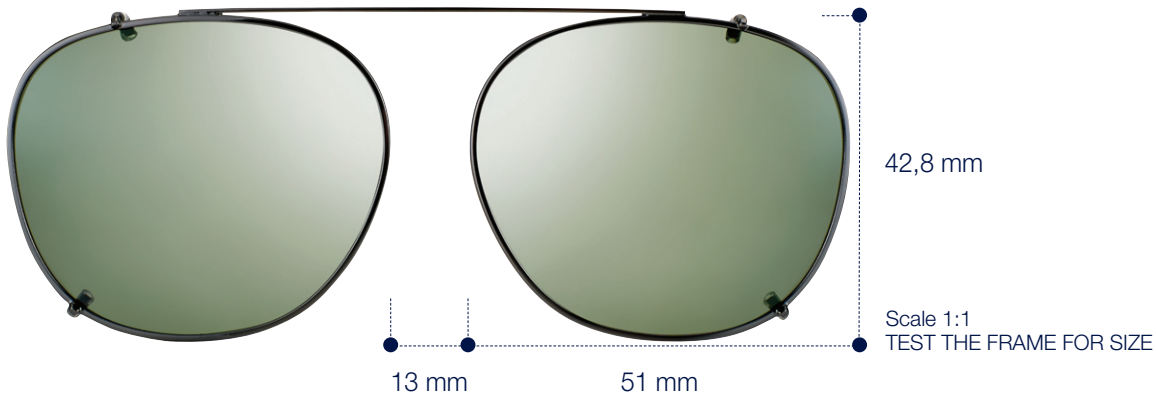

Polarized Lenses 100% UVA-UVB protection up to 390 nm | Filter Category 3 | **CE**

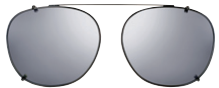

Gun Metal/Smoke Lenses
Ref. C0439 51 046 001



Gun Metal/G15 Lenses
Ref. C0439 51 046 002

 1 pc.

CE SPECIFICATIONS
IN ACCORDANCE WITH
REGULATION (UE) 2016/425

Case included.



FOR PLASTIC AND METAL FRAMES

- Anti-scratch hooks
- Case included
- Flexible bridge
- Ideal for Sized 4 You Ref. **F0303 49**

FOR FRAME - SIZE 49-51

FIXED

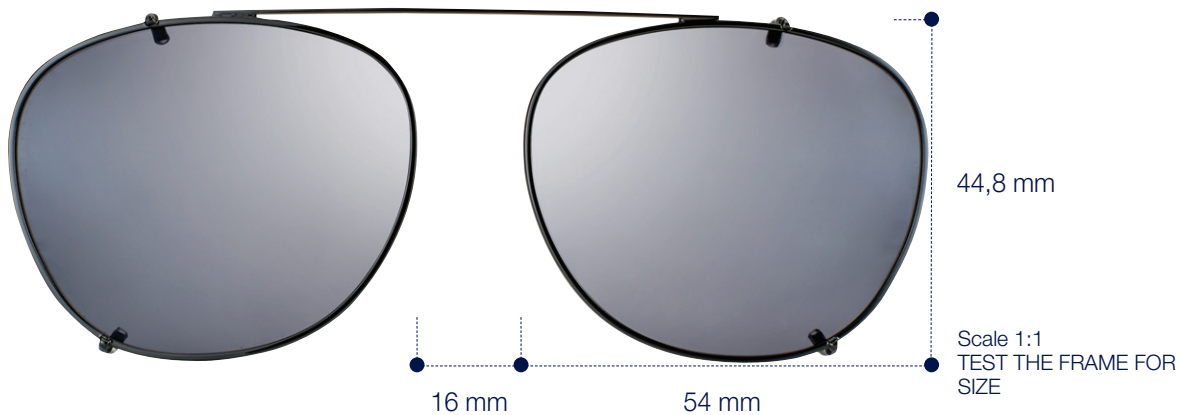

Polarized Lenses 100% UVA-UVB protection up to 390 nm | Filter Category 3 | **CE**



Gun Metal/Smoke Lenses
Ref. C0439 54 046 001



Gun Metal/G15 Lenses
Ref. C0439 54 046 002

 1 pc.

CE SPECIFICATIONS
IN ACCORDANCE WITH
REGULATION (UE) 2016/425

Case included.



FOR PLASTIC AND METAL FRAMES

- Anti-scratch hooks
- Case included
- Flexible bridge
- Ideal for Sized 4 You Ref. **F0303 52**

FOR FRAME - SIZE 52-54

FIXED

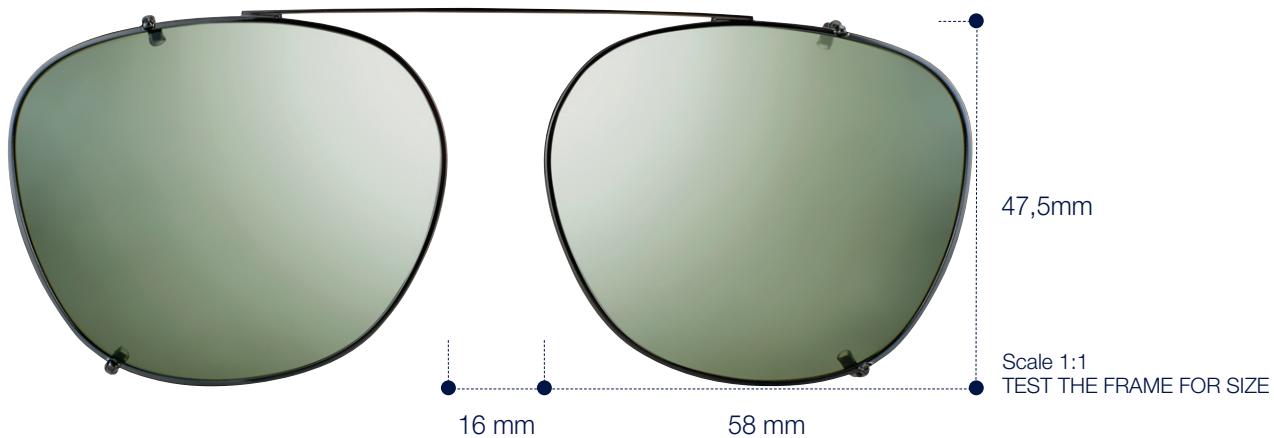

Polarized Lenses 100% UVA-UVB protection up to 390 nm | Filter Category 3 | **CE**

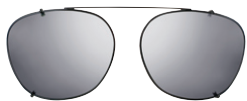

Gun Metal/Smoke Lenses
Ref. C0439 58 046 001



Gun Metal/G15 Lenses
Ref. C0439 58 046 002

 1 pc.

Case included.



FOR PLASTIC AND METAL FRAMES

- Anti-scratch hooks
- Case included
- Flexible bridge

FOR FRAME - SIZE 49-51

FIXED

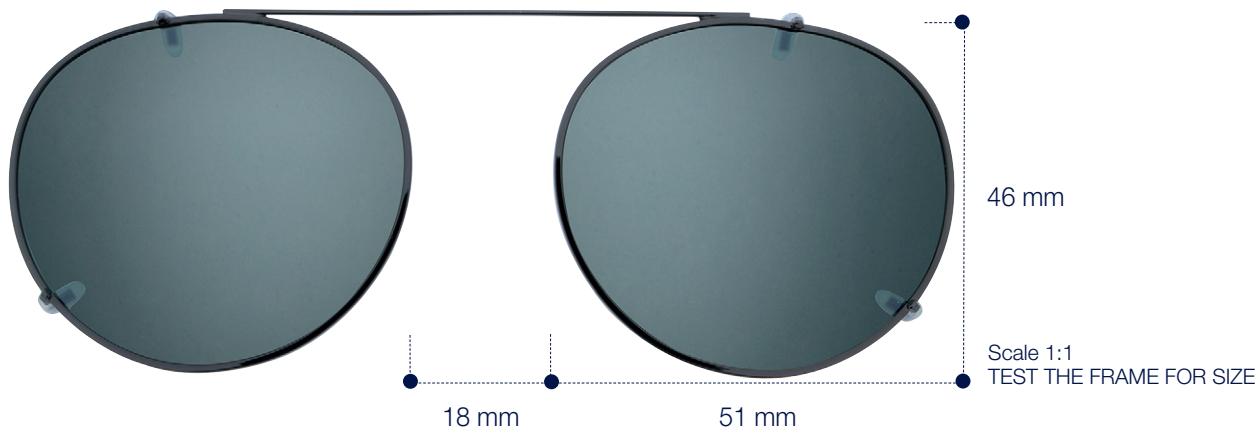

Polarized Lenses 100% UVA-UVB protection up to 390 nm | Filter Category 3 | CE

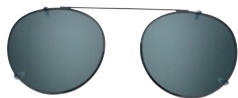

Gun Metal/G15 Flash Silver Lenses
Ref. C0034 51 019 005

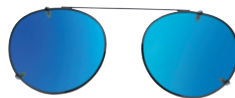

Gun Metal/Grey Light Blue Mirror Lenses
Ref. C0034 51 019 008

 1 pc.

CE SPECIFICATIONS
IN ACCORDANCE WITH
REGULATION (UE) 2016/425

Case included.



FOR PLASTIC AND METAL FRAMES

- Anti-scratch hooks
- Case included
- Flexible bridge

FOR FRAME - SIZE 53

FIXED

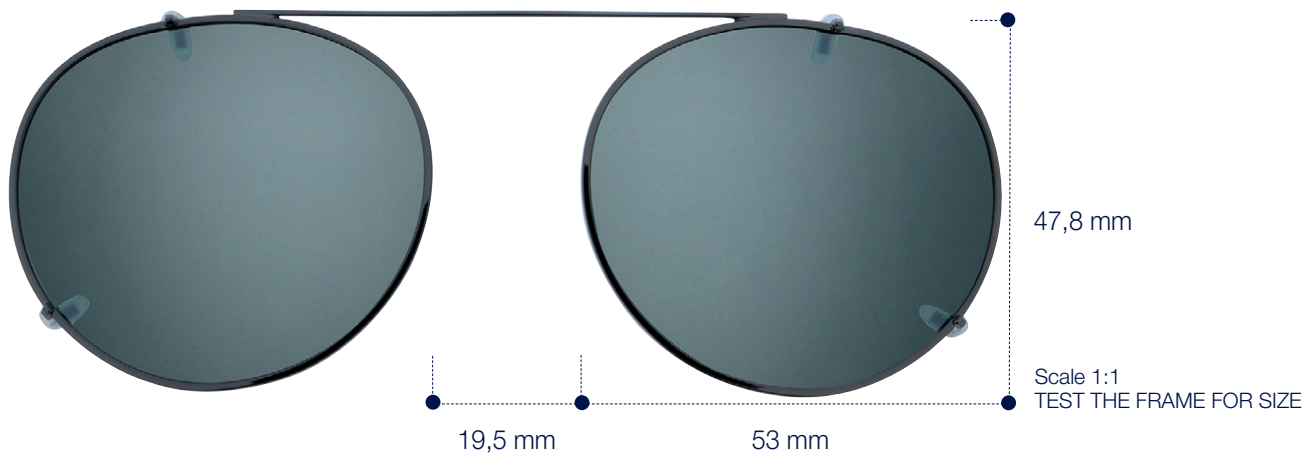

Polarized Lenses 100% UVA-UVB protection up to 390 nm | Filter Category 3 | **CE**



Gun Metal/G15 Flash Silver Lenses

Ref. C0034 53 019 005

 1 pc.

Case included.



FOR PLASTIC AND METAL FRAMES

- Anti-scratch hooks
- Case included
- Flexible bridge

FOR FRAME - SIZE 49-51

FIXED

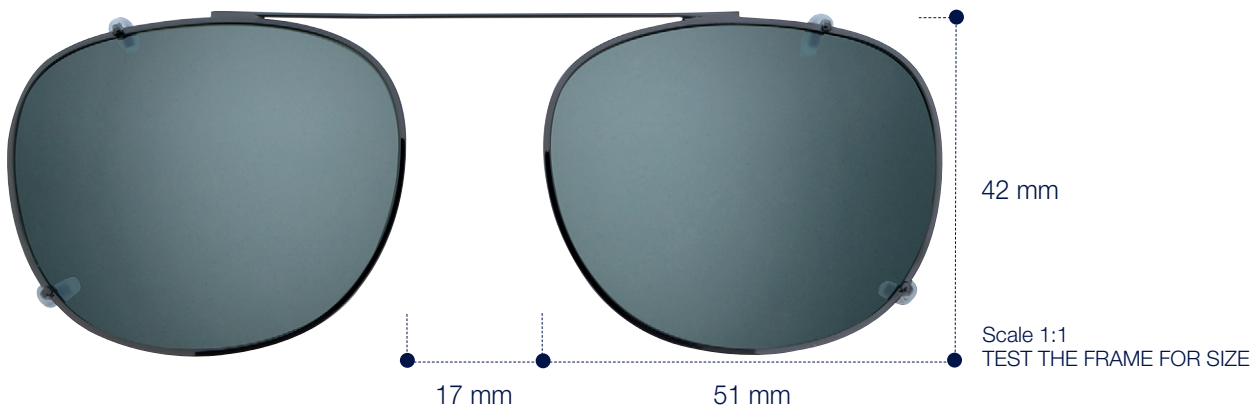

Polarized Lenses 100% UVA-UVB protection up to 390 nm | Filter Category 3 | CE



Gun Metal/G15 Lenses
Ref. C0035 51 019 005

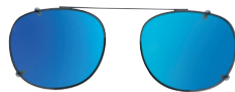

Gun Metal/Grey Light Blue Mirror Lenses
Ref. C0035 51 019 008

 1 pc.

CE SPECIFICATIONS
IN ACCORDANCE WITH
REGULATION (UE) 2016/425

Case included.



FOR PLASTIC AND METAL FRAMES

- Anti-scratch hooks
- Case included
- Adjustable spring bridge

FOR FRAME - SIZE 54

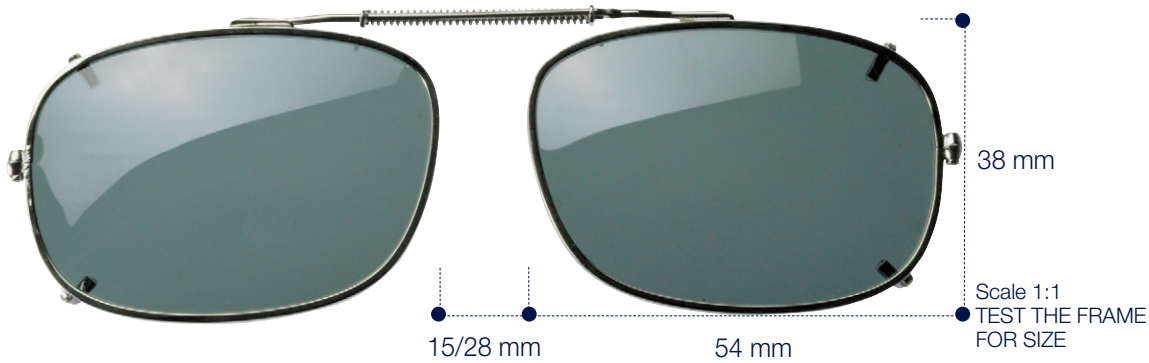

FIXED



Gun Metal/Grey Lenses

Ref. 12461 □ 54 📦 1 pc.

FOR FRAME - SIZE 58

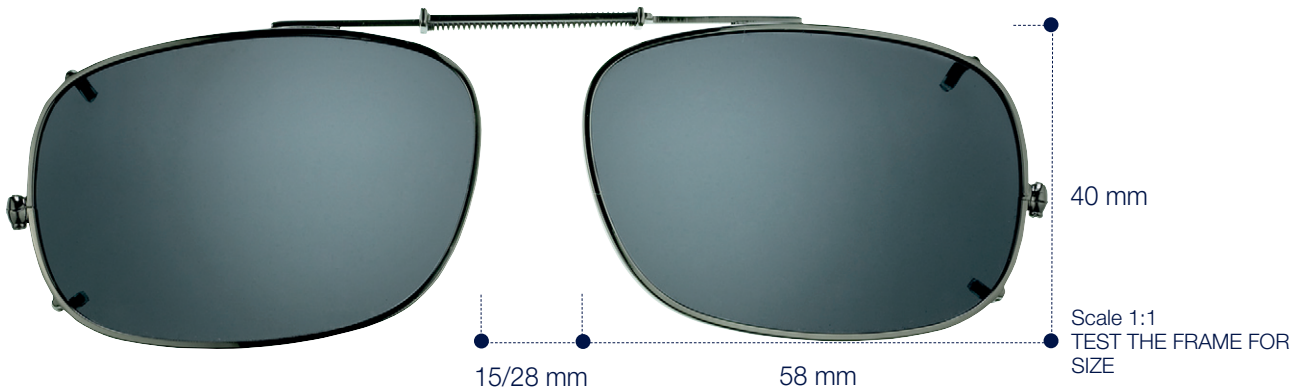

Gun Metal/Grey Lenses

Ref. 12464 □ 58



Gun Metal/G15 Lenses

Ref. 12465 □ 58

📦 1 pc.



Case included.



FIT-OVER

To be worn **over prescription eyewear.**

Protect the eyes 100% from UVA and UVB sun rays. Lightweight and comfortable. The **wrap-around shape** and polarized quality lenses **reduce eye fatigue.**



FOR PLASTIC AND METAL FRAMES

NEW

- Polycarbonate front and TR90 sides
- Case included

145 B 2 146



Polarized Lenses 100% UVA-UVB protection up to 400 nm | Filter Category 3 | CE



Matt Black
Smoke Lenses

Ref. S0522 00 002 001



Matt Demy
G15 Lenses

Ref. S0522 00 010 002

CE SPECIFICATIONS
IN ACCORDANCE WITH
REGULATION (UE) 2016/425



CE
centrostyle
208193
S 6922 00 010 092 145-145 POLARIZED

FOR PLASTIC AND METAL FRAMES

- Grilamid Frame
- Case included



FOR FRAME - SIZE 53

□ 53) 19 B 6 ~ 135



50 mm

Inner Dimensions 135 mm

Scale 1:1
TEST THE FRAME FOR SIZE

Polarized Lenses 100% UVA-UVB protection up to 400 nm | Filter Category 3 | CE



Matt Black
Smoke Lenses

Ref. S0084 53 002 001 □ 53



Matt Demy
Brown Lenses

Ref. S0084 53 169 003 □ 53



Matt Black
Yellow Lenses FC1

Ref. S0084 53 002 034 □ 53



CE SPECIFICATIONS
IN ACCORDANCE WITH
REGULATION (UE) 2016/425

FOR PLASTIC AND METAL FRAMES

- Grilamid Frame
- Case included



FOR FRAME - SIZE 54

□ 54) 17 B 6 ~ 135



Polarized Lenses 100% UVA-UVB protection up to 400 nm | Filter Category 3 | CE



Shiny Dark Blue
Smoke Lenses

Ref. S0092 54 124 001 □ 54



Shiny Black
Smoke Lenses

Ref. S0092 54 001 001 □ 54





FOR PLASTIC AND METAL FRAMES

- Grilamid Frame
- Case included



FOR FRAME - SIZE 60

□ 60 ⌵ 15 B 6 ⌵ 150



Polarized Lenses 100% UVA-UVB protection up to 400 nm | Filter Category 3 | CE



Black/Smoke Lenses

Ref. 12705 □ 60



Demi Brown/Brown Lenses

Ref. 12706 □ 60



Matt Black/Yellow Lenses FC1

Ref. 12709 □ 62

FOR PLASTIC AND METAL FRAMES

- Grilamid Frame
- Case included



FOR FRAME - SIZE 62

□ 62 ⌵ 13 Ⓚ 6 ⌒ 145



Polarized Lenses 100% UVA-UVB protection up to 400 nm | Filter Category 3 | **CE**



Black/Smoke Lenses

Ref. 12707 □ 62



Demi Brown/Brown Lenses

Ref. 12708 □ 62



CE SPECIFICATIONS
IN ACCORDANCE WITH
REGULATION (UE) 2016/425

FOR PLASTIC AND METAL FRAMES

- Grilamid Frame
- Case included



FOR FRAME - SIZE 57

□ 57 ⌒ 16 B 6 ⌒ 145



Polarized Lenses 100% UVA-UVB protection up to 400 nm | Filter Category 3 | CE



Matt Black
Smoke Lenses

Ref. 12716 □ 57



Matt Demi
Brown Lenses

Ref. 12717 □ 57



Matt Black
Yellow Lenses FC1

Ref. 12718 □ 57

FOR PLASTIC AND METAL FRAMES

- Grilamid Frame
- **2 sets of Lenses**
- Case included

FOR FRAME - SIZE 63

□ 63 ⌒ 15 B 6 ⌒ 140



41 mm

Scale 1:1

TEST THE FRAME FOR SIZE

Inner Dimensions 125 mm

Polycarbonate Lenses 100% UVA-UVB protection up to 400 nm | Filter Category 3 | **CE**



Black/Smoke Flash Mirror
Lenses FC3

Ref. 12700 □ 63



INCLUDED

Orange Lenses FC1



Smoke Flash Mirror Lenses FC 3

Ref. 12700LS

INDIVIDUALLY SELLABLE



CE SPECIFICATIONS
IN ACCORDANCE WITH
REGULATION (UE) 2016/425

Side shields with polarized
filters and slip-proof temple
tip inserts.

ORANGE LENSES

To neutralize the excess of blue light
and its negative effects, allowing a
clear vision and a better visual comfort
(cloudy and foggy weather).

Lenses easy to interchange
thanks to click on shape.



VISIBILITY

Ref. CK0001

12 pcs.

1 pc. / Ref.



Ref. CK0002

12 pcs.

1 pc. / Ref.



Ref. 11277
Only Couvette



Ref. CK0003
12 pcs.
1 pc. / Ref.



centrostyle.com    