

centrostyle®
around PEOPLE

CLIP-ONS & FIT OVER







FOR PLASTIC FRAMES

Clip-Ons with minimal mechanism, trimmable lenses and anti-scratch clips for plastic frames. Polarized lenses for maximum protection against UVA and UVB rays.



FOR METAL FRAMES

Clip-Ons with minimal mechanism, trimmable lenses and anti-scratch clips for metal frames. Polarized lenses for maximum protection against UVA and UVB rays.



TRIMMABLE FLIP-UPS

Flip-Ups with minimal mechanism, trimmable lenses and anti-scratch clips. Polarized lenses for maximum protection against UVA and UVB rays.



TRIMMABLE FIXED

Clip-Ons with minimal mechanism, trimmable lenses and anti-scratch clips. Polarized lenses for maximum protection against UVA and UVB rays.

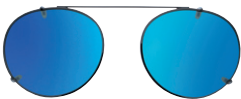

METAL RIM CLIP-ONS

Clip-Ons with anti-scratch clips. Polarized lenses for maximum protection against UVA and UVB rays.



SUN-SHIELD

To be worn over prescription eyewear. The wrap-around shape protect the eyes from UVA and UVB rays.

pg. 4

pg. 32

pg. 52

pg. 66

pg. 72

pg. 76

FOR PLASTIC FRAMES



Ref. CK0001

Kit of 12 clip-on of your choice

Minimal mechanism for **plastic frame**.



Ref. 11277

Only Couvette

FIXED CLIP-ON WITH MINIMAL MECHANISM

FOR **PLASTIC**
FRAMES



Advice for correct use:

- Do not use force
- Do not try to flip them up

1.

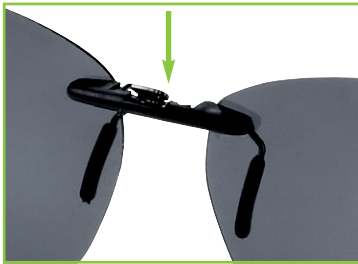

Backing card with technical data and indication of size.

2.



3.



Test the frame for size.

CLIP-ON

for **PLASTIC** frames

54-56

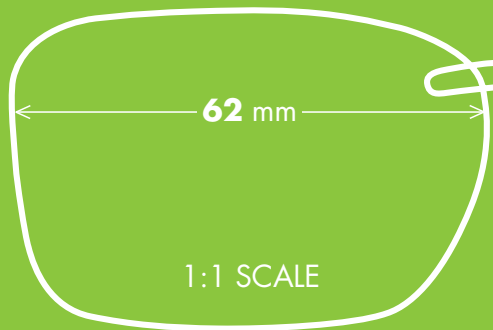

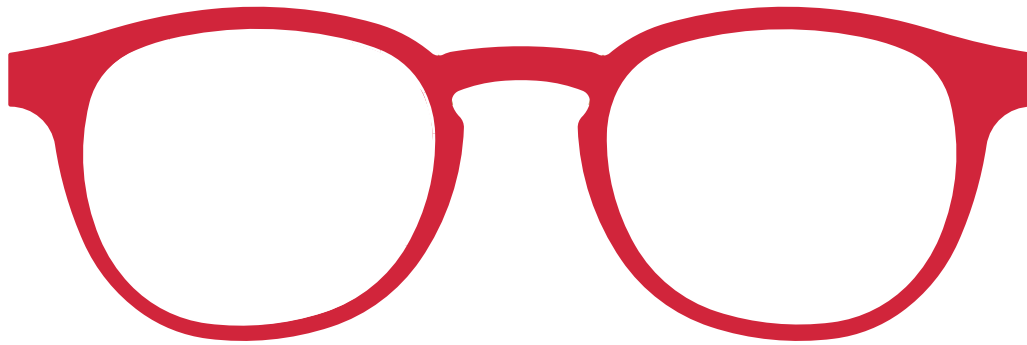

Fixed Clip-On

Suitable for

PANTHOS shapes



FOR PLASTIC FRAMES

- Trimmable Lenses
- Anti-scratch hooks
- Case included

FOR FRAME - SIZE 48-50

FIXED



Polarized Lenses 100% UVA-UVB protection up to 390 nm | Filter Category 3 | **CE**



Smoke

Ref. C0275 55 019 001 55



Brown

Ref. C0275 55 019 003 55



G15

Ref. C0275 55 019 002

1 pc.

CE SPECIFICATIONS
IN ACCORDANCE WITH
REGULATION (UE) 2016/425

Case included.



■ FOR PLASTIC FRAMES

- Trimmable Lenses
- Anti-scratch hooks
- Case included

FOR FRAME - SIZE 46-50

FIXED



Polarized Lenses 100% UVA-UVB protection up to 390 nm | Filter Category 3 | CE



Grey

Ref. 12792



Brown

Ref. 12793



G15

Ref. 12794



Case included.



■ FOR PLASTIC FRAMES

- Trimmable Lenses
- Anti-scratch hooks
- Case included

FOR FRAME - SIZE 49-53

FIXED



Polarized Lenses 100% UVA-UVB protection up to 390 nm | Filter Category 3 | **CE**



Grey

Ref. C0060 56 019 001



G15

Ref. C0060 56 019 002



Brown

Ref. C0060 56 019 003

1 pc.

CE SPECIFICATIONS
IN ACCORDANCE WITH
REGULATION (UE) 2016/425

Case included.



■ FOR PLASTIC FRAMES

- Trimmable Lenses
- Anti-scratch hooks
- Case included

FOR FRAME - SIZE 49-53

FIXED

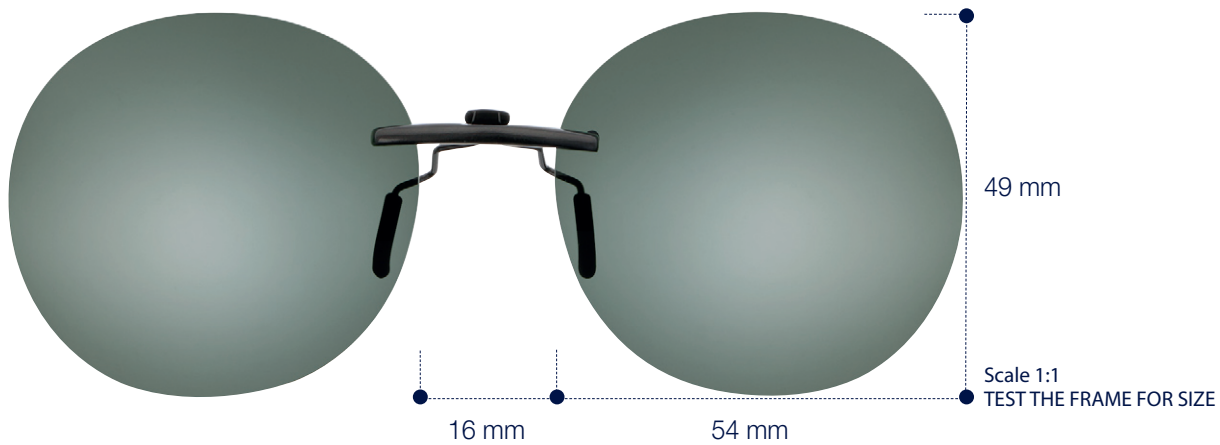

Polarized Lenses 100% UVA-UVB protection up to 390 nm | Filter Category 3 | CE



Grey

Ref. C0097 54 019 001



G15

Ref. C0097 54 019 002

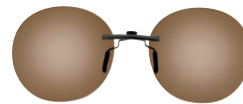

Brown

Ref. C0097 54 019 003

 1 pc.

Case included.





Fixed Clip-On

Suitable for

CAT-EYE shapes

■ FOR PLASTIC FRAMES

- Trimmable Lenses
- Anti-scratch hooks
- Case included

FOR FRAME - SIZE 60

FIXED

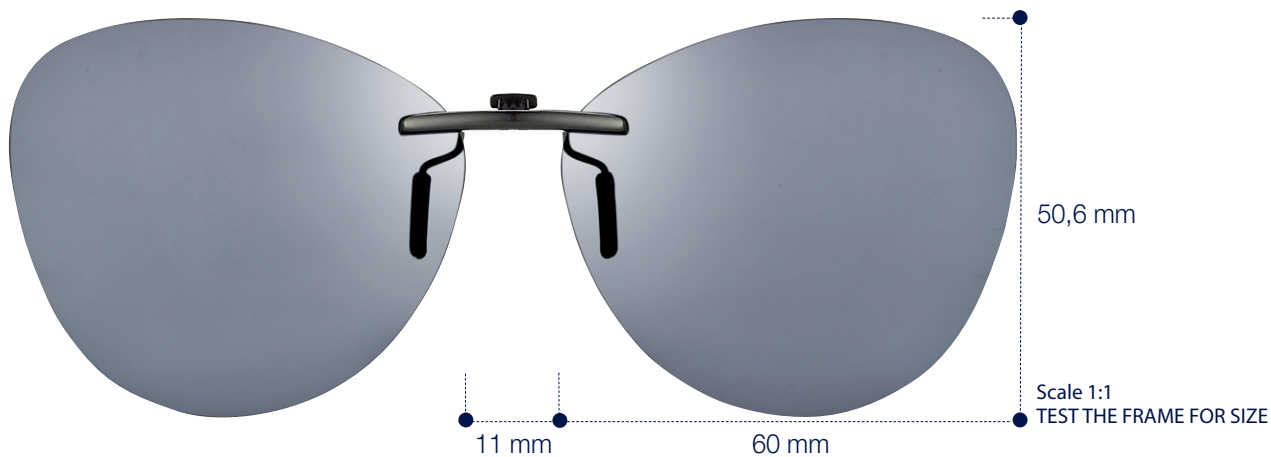

Polarized Lenses 100% UVA-UVB protection up to 390 nm | Filter Category 3 | **CE**



Smoke

Ref. C0354 60 019 001



G15

Ref. C0354 60 019 002



Brown

Ref. C0354 60 019 003

 1 pc.

CE SPECIFICATIONS
IN ACCORDANCE WITH
REGULATION (UE) 2016/425

Case included.



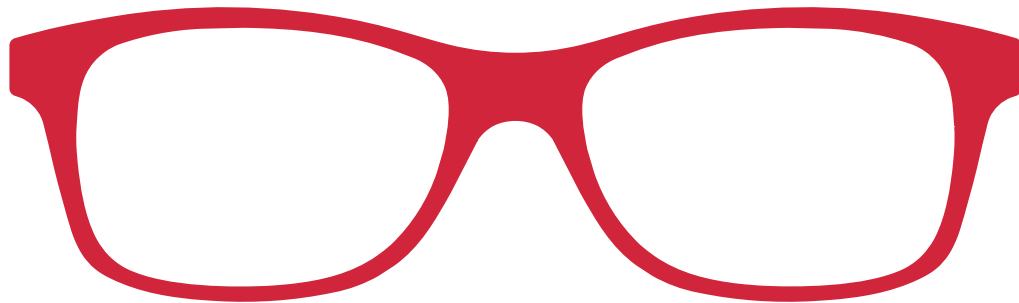
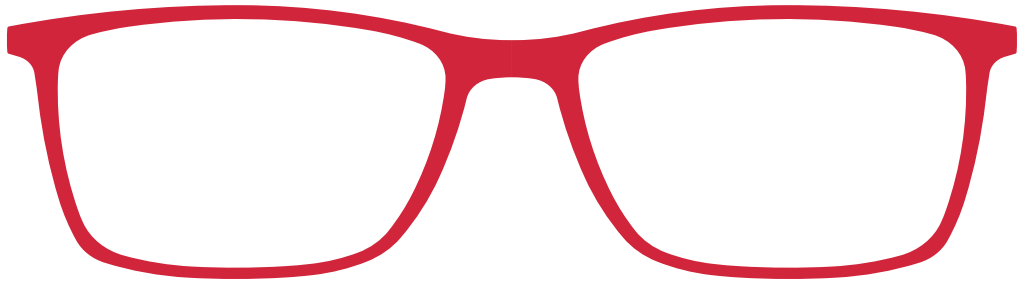

Fixed Clip-On

Suitable for

RECTANGULAR shapes



■ FOR PLASTIC FRAMES

- Trimmable Lenses
- Anti-scratch hooks
- Case included

FOR FRAME - SIZE 50-53

FIXED

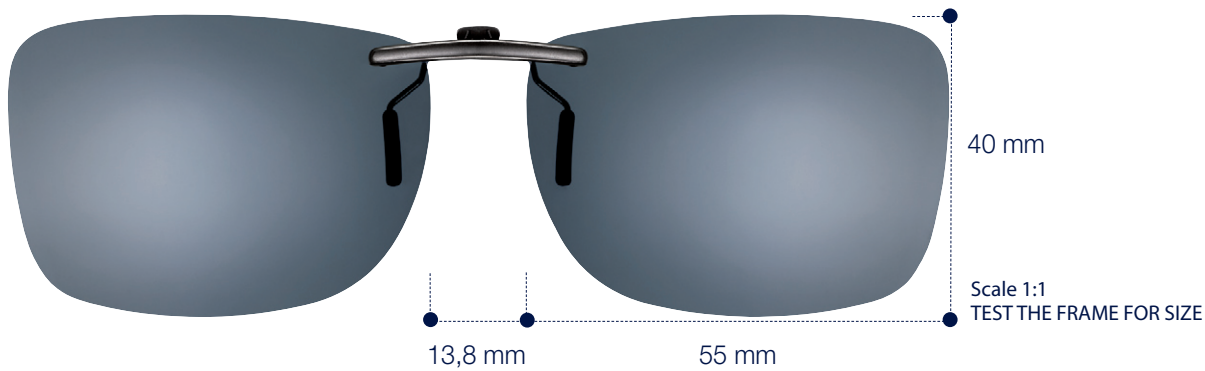

Polarized Lenses 100% UVA-UVB protection up to 390 nm | Filter Category 3 | CE



Grey

Ref. 12777



G15

Ref. 12778

 1 pc.

CE SPECIFICATIONS
IN ACCORDANCE WITH
REGULATION (UE) 2016/425

Case included.



FOR PLASTIC FRAMES

- Trimmable Lenses
- Anti-scratch hooks
- Case included

FOR FRAME - SIZE 50-53

FIXED



Polarized Lenses 100% UVA-UVB protection up to 390 nm | Filter Category 3 | CE



Grey

Ref. 12780  1 pc.



G15

Ref. 12781  1 pc.



Brown

Ref. 12782  1 pc.



Yellow FC 1

Ref. 12797  1 pc.



G15/Yellow Mirror

Ref. 12884  1 pc.



Brown/Dark Red Mirror

Ref. 12885  1 pc.

Case included.



■ FOR PLASTIC FRAMES

- Trimmable Lenses
- Anti-scratch hooks
- Case included

FOR FRAME - SIZE 53-55

FIXED



Polarized Lenses 100% UVA-UVB protection up to 390 nm | Filter Category 3 | CE



Smoke

Ref. C0274 58 019 001



G15

Ref. C0274 58 019 002



Brown

Ref. C0274 58 019 003

 1 pc.

CE SPECIFICATIONS
IN ACCORDANCE WITH
REGULATION (UE) 2016/425

Case included.



■ FOR PLASTIC FRAMES

- Trimmable Lenses
- Anti-scratch hooks
- Case included

FOR FRAME - SIZE 52-54

FIXED



Polarized Lenses 100% UVA-UVB protection up to 390 nm | Filter Category 3 | CE



Grey
Ref. 12783



G15
Ref. 12784



Brown
Ref. 12785

 1 pc.

Case included.



■ FOR PLASTIC FRAMES

- Trimmable Lenses
- Anti-scratch hooks
- Case included

FOR FRAME - SIZE 51-55

FIXED

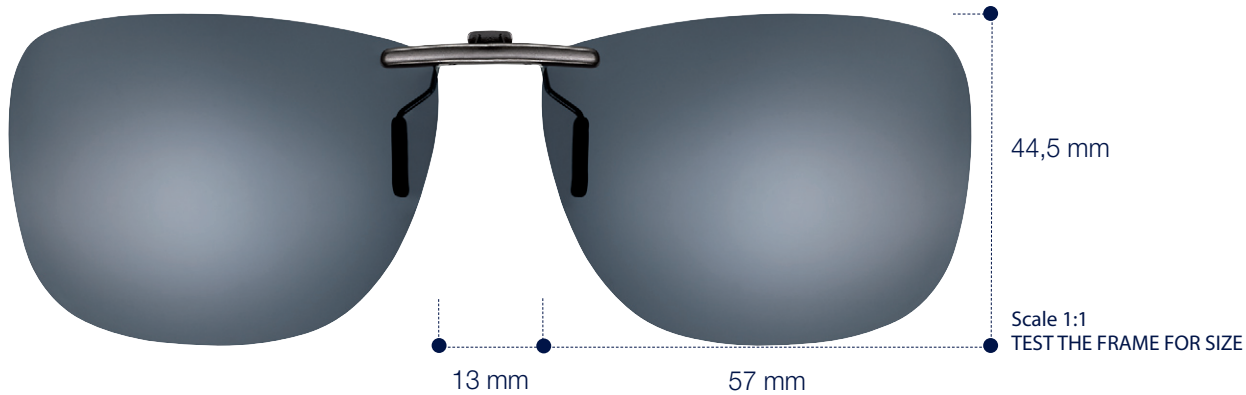

Polarized Lenses 100% UVA-UVB protection up to 390 nm | Filter Category 3 | **CE**



Grey

Ref. 12786



G15

Ref. 12787



Brown

Ref. 12788

 1 pc.

CE SPECIFICATIONS
IN ACCORDANCE WITH
REGULATION (UE) 2016/425

Case included.



■ FOR PLASTIC FRAMES

- Trimmable Lenses
- Anti-scratch hooks
- Case included

FOR FRAME - SIZE 50-53

FIXED

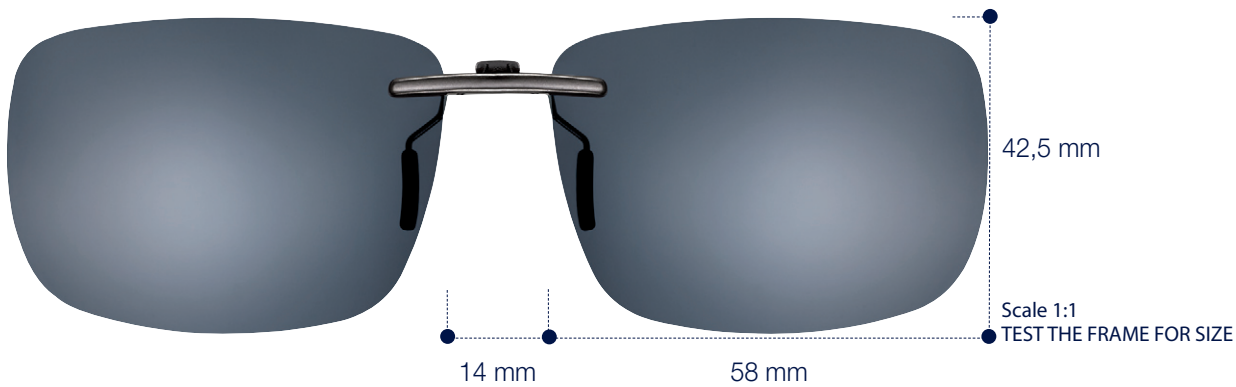

Polarized Lenses 100% UVA-UVB protection up to 390 nm | Filter Category 3 | CE



Grey
Ref. 12789



G15
Ref. 12790



Brown
Ref. 12791

1 pc.



G15/Yellow Mirror
Ref. 12887

1 pc.



Brown/Dark Red Mirror
Ref. 12888

1 pc.

Case included.



■ FOR PLASTIC FRAMES

- Trimmable Lenses
- Anti-scratch hooks
- Case included

FOR FRAME - SIZE 56-58

FIXED



Polarized Lenses 100% UVA-UVB protection up to 390 nm | Filter Category 3 | **CE**



Grey
Ref. 12765



G15
Ref. 12766



Brown
Ref. 12767

 1 pc.

CE SPECIFICATIONS
IN ACCORDANCE WITH
REGULATION (UE) 2016/425

Case included.





■ FOR RIMLESS FRAMES

- Trimmable Lenses
- Anti-scratch hooks
- Case included

FOR RIMLESS FRAMES WITH LOW CURVATURE LENSES SIZE 50-52

FIXED

(The clip-on must not touch the lens in the centre)



Polarized Lenses 100% UVA-UVB protection up to 390 nm | Filter Category 3 | CE



Grey
Ref. 12771



G15
Ref. 12772



Brown
Ref. 12773

 1 pc.

CE SPECIFICATIONS
IN ACCORDANCE WITH
REGULATION (UE) 2016/425

Case included.



■ FOR RIMLESS FRAMES

- Trimmable Lenses
- Anti-scratch hooks
- Case included

FOR RIMLESS FRAMES WITH LOW CURVATURE LENSES SIZE 50-52

FIXED

(The clip-on must not touch the lens in the centre)



Polarized Lenses 100% UVA-UVB protection up to 390 nm | Filter Category 3 | CE



Grey
Ref. 12768



G15
Ref. 12769



Brown
Ref. 12770

 1 pc.

Case included.





Fixed Clip-On

Suitable for

WIDE SQUARE shapes

■ FOR PLASTIC FRAMES

- Trimmable Lenses
- Anti-scratch hooks
- Case included

FOR FRAME - SIZE 59

FIXED

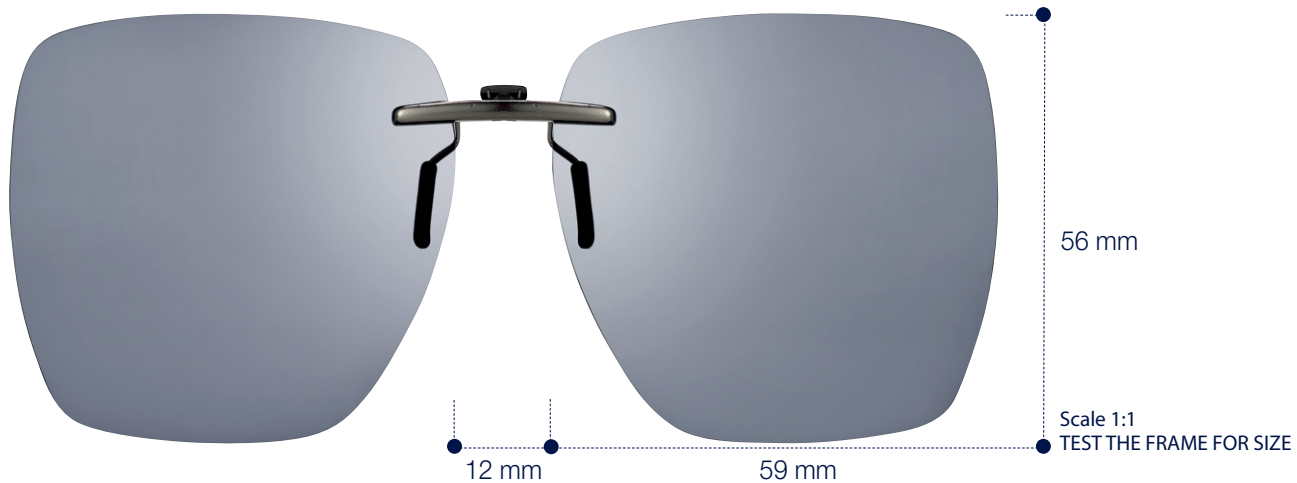

Polarized Lenses 100% UVA-UVB protection up to 390 nm | Filter Category 3 | **CE**



Smoke

Ref. C0353 59 019 001



G15

Ref. C0353 59 019 002



Brown

Ref. C0353 59 019 003

 1 pc.

CE SPECIFICATIONS
IN ACCORDANCE WITH
REGULATION (UE) 2016/425

Case included.



■ FOR PLASTIC FRAMES

- Trimmable Lenses
- Anti-scratch hooks
- Case included

FOR FRAME - SIZE 55-57

FIXED



Polarized Lenses 100% UVA-UVB protection up to 390 nm | Filter Category 3 | **CE**



Smoke

Ref. C0273 62 019 001



G15

Ref. C0273 62 019 002



Brown

Ref. C0273 62 019 003

1 pc.

CE SPECIFICATIONS
IN ACCORDANCE WITH
REGULATION (UE) 2016/425

Case included.







CLIP-ON TRIMMABLE/FIXED

Clip-ons with minimal mechanism, **trimmable lenses** and anti-scratch clips. Easy to put on and take off by pressing the central spring. **Polarized lenses** for **maximum protection against UVA and UVB rays.**

■ FOR PLASTIC FRAMES

- Trimmable Lenses
- Anti-scratch hooks
- Case included

Polarized Lenses 100% UVA-UVB protection up to 390 nm | Filter Category 3 | **CE**

FIXED

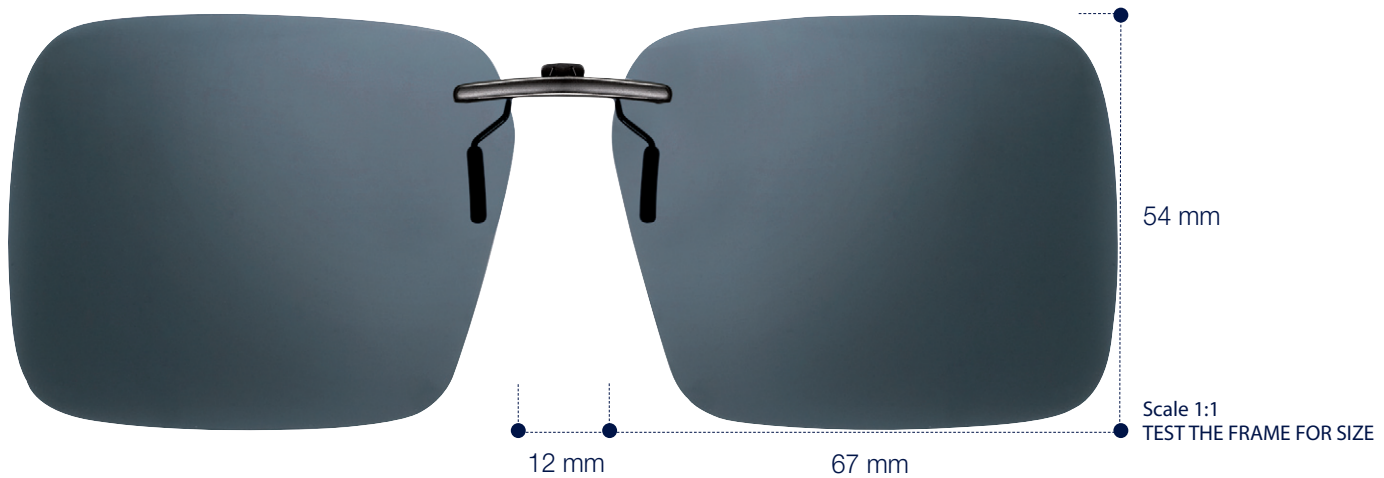

Grey
Ref. 12774



G15
Ref. 12775



Brown
Ref. 12776

1 pc.



Yellow FC 1
Ref. 12799

1 pc.

CE SPECIFICATIONS
IN ACCORDANCE WITH
REGULATION (UE) 2016/425

Case included.



FOR METAL FRAMES

Ref. CK0002

Kit of 12 clip-on of your choice
Minimal mechanism for **metal frame**.



Ref. 11277

Only Couvette



FIXED CLIP-ON WITH MINIMAL MECHANISM

FOR **METAL**
FRAMES



Advice for correct use:

- Do not use force
- Do not try to flip them up

1.

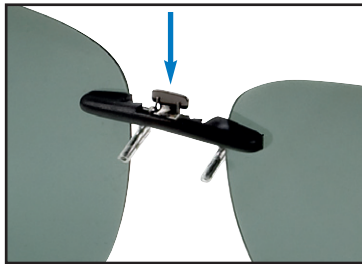

2.

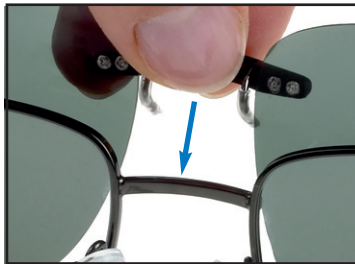

3.

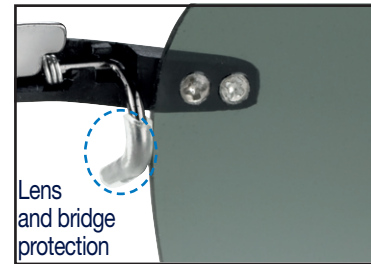

Backing card with technical data and indication of size.

Test the frame for size.

CLIP-ON

for **METAL** frames

58

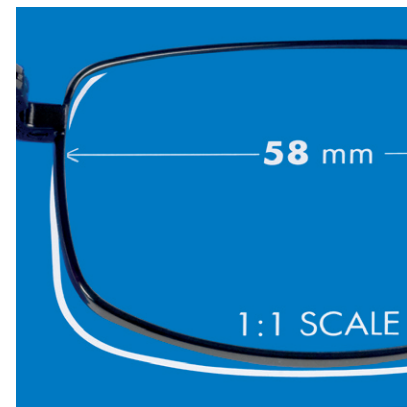
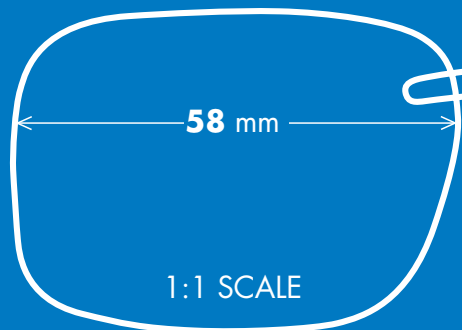

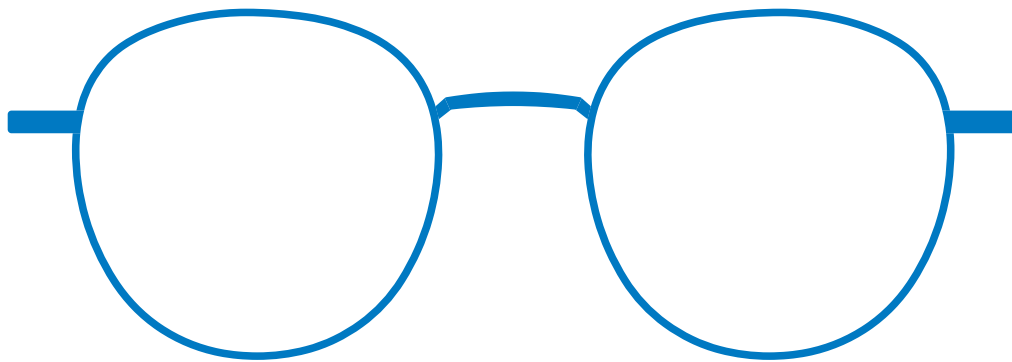

Fixed Clip-On

Suitable for

PANTHOS shapes



■ FOR METAL FRAMES

- Trimmable Lenses
- Anti-scratch hooks
- Case included

FOR FRAME - SIZE 53

FIXED



Polarized Lenses 100% UVA-UVB protection up to 390 nm | Filter Category 3 | CE



Grey

Ref. C0352 53 019 001



G15

Ref. C0352 53 019 002



Brown

Ref. C0352 53 019 003

1 pc.

CE SPECIFICATIONS
IN ACCORDANCE WITH
REGULATION (UE) 2016/425

Case included.



■ FOR METAL FRAMES

- Trimmable Lenses
- Anti-scratch hooks
- Case included

FOR FRAME - SIZE 49-53

FIXED

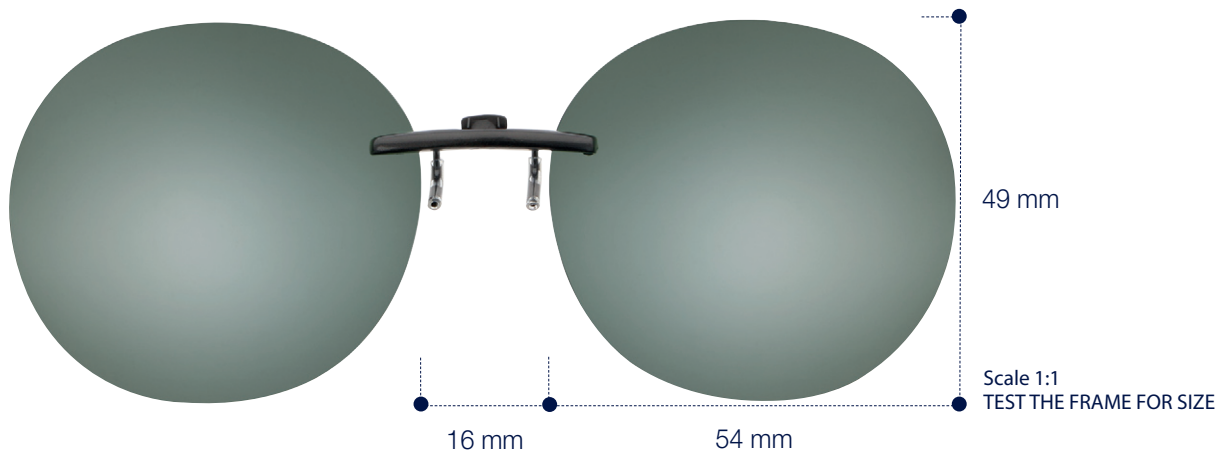

Polarized Lenses 100% UVA-UVB protection up to 390 nm | Filter Category 3 | CE



Grey

Ref. C0096 54 019 001



G15

Ref. C0096 54 019 002



Brown

Ref. C0096 54 019 003

📦 1 pc.

Case included.



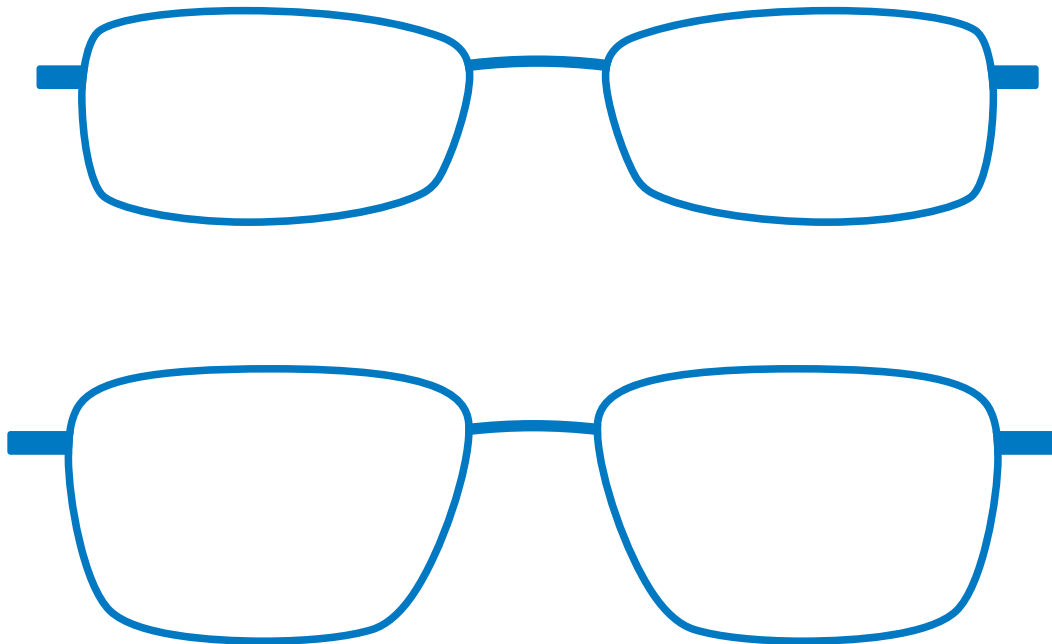

Fixed Clip-On

Suitable for

RECTANGULAR shapes



■ FOR METAL FRAMES

- Trimmable Lenses
- Anti-scratch hooks
- Case included

FOR FRAME - SIZE 49-51

FIXED



Polarized Lenses 100% UVA-UVB protection up to 390 nm | Filter Category 3 | CE



Grey
Ref. 12764



G15
Ref. 12795



Brown
Ref. 12796

 1 pc.

CE SPECIFICATIONS
IN ACCORDANCE WITH
REGULATION (UE) 2016/425

Case included.



■ FOR METAL FRAMES

- Trimmable Lenses
- Anti-scratch hooks
- Case included

FOR FRAME - SIZE 50-53

FIXED



Polarized Lenses 100% UVA-UVB protection up to 390 nm | Filter Category 3 | CE



Grey
Ref. 12756

1 pc.



G15
Ref. 12757

1 pc.



Brown
Ref. 12758

1 pc.



Yellow FC 1
Ref. 12805

1 pc.

Case included.



■ FOR METAL FRAMES

- Trimmable Lenses
- Anti-scratch hooks
- Case included

FOR FRAME - SIZE 52-55

FIXED



Polarized Lenses 100% UVA-UVB protection up to 390 nm | Filter Category 3 | CE



Grey
Ref. 12753



G15
Ref. 12754



Brown
Ref. 12755

1 pc.



Yellow FC 1
Ref. 12798

1 pc.

CE SPECIFICATIONS
IN ACCORDANCE WITH
REGULATION (UE) 2016/425

Case included.



■ FOR METAL FRAMES

- Trimmable Lenses
- Anti-scratch hooks
- Case included

FOR FRAME - SIZE 52-55

FIXED

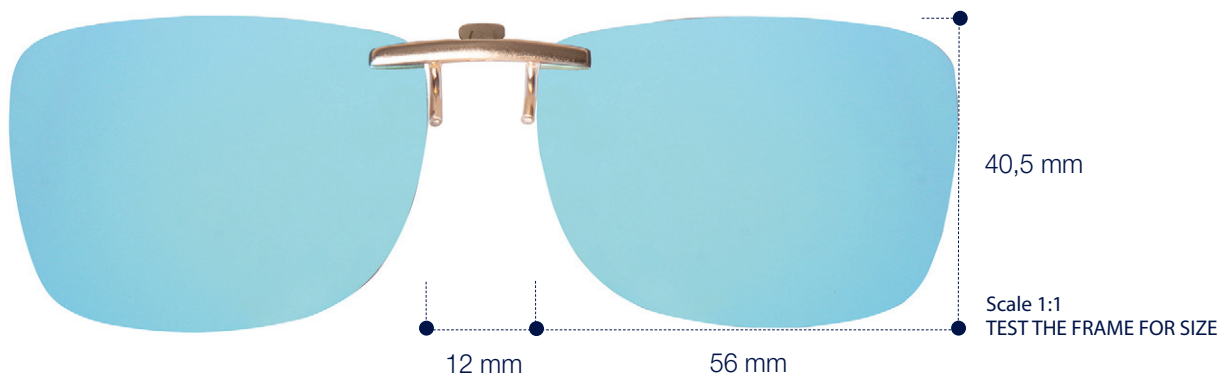

Polarized Lenses 100% UVA-UVB protection up to 390 nm | Filter Category 3 | 



Gold/Blue Multilayer
Ref. 12812



Silver/Blue Multilayer
Ref. 12813

 1 pc.

Case included.



■ FOR METAL FRAMES

- Trimmable Lenses
- Anti-scratch hooks
- Case included

FOR FRAME - SIZE 52-55

FIXED

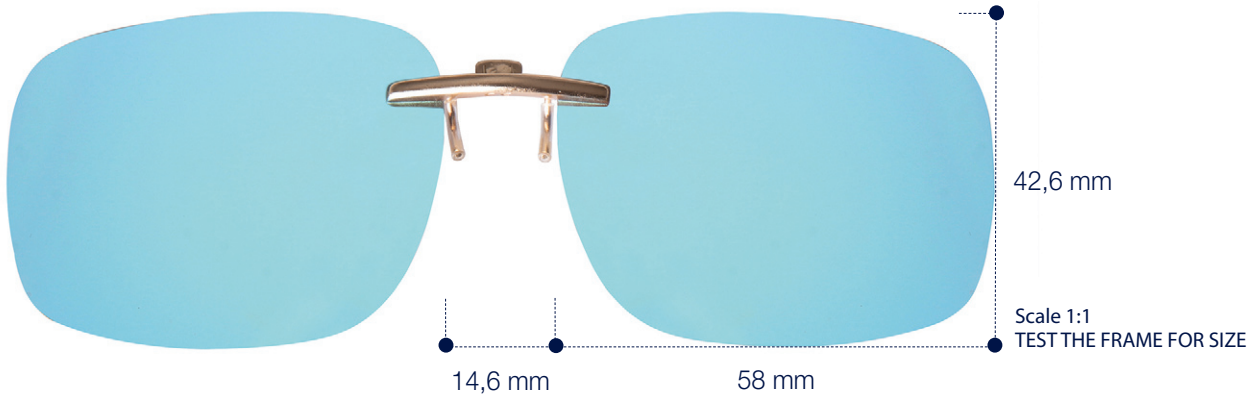

Polarized Lenses 100% UVA-UVB protection up to 390 nm | Filter Category 3 | **CE**



Gold/Blue Multilayer

Ref. 12802



Silver/Blue Multilayer

Ref. 12803

 1 pc.

CE SPECIFICATIONS
IN ACCORDANCE WITH
REGULATION (UE) 2016/425

Case included.



■ FOR METAL FRAMES

- Trimmable Lenses
- Anti-scratch hooks
- Case included

FOR FRAME - SIZE 52-55

FIXED

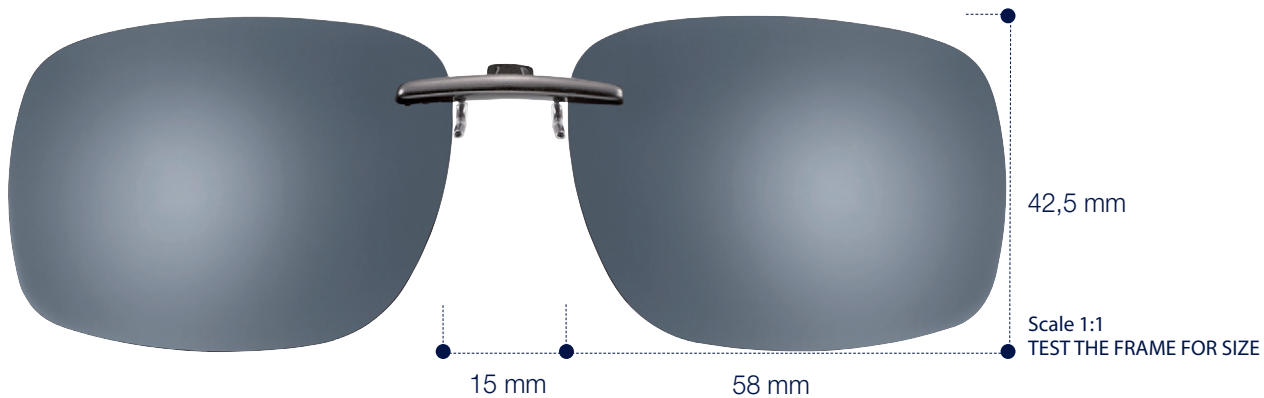

Polarized Lenses 100% UVA-UVB protection up to 390 nm | Filter Category 3 | 



Grey

Ref. 12750



G15

Ref. 12751



Brown

Ref. 12752

 1 pc.



G15/Yellow Mirror

Ref. 12881

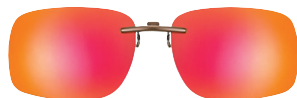

Brown/Dark Red Mirror

Ref. 12882



Yellow FC 1

Ref. 12806

 1 pc.

Case included.



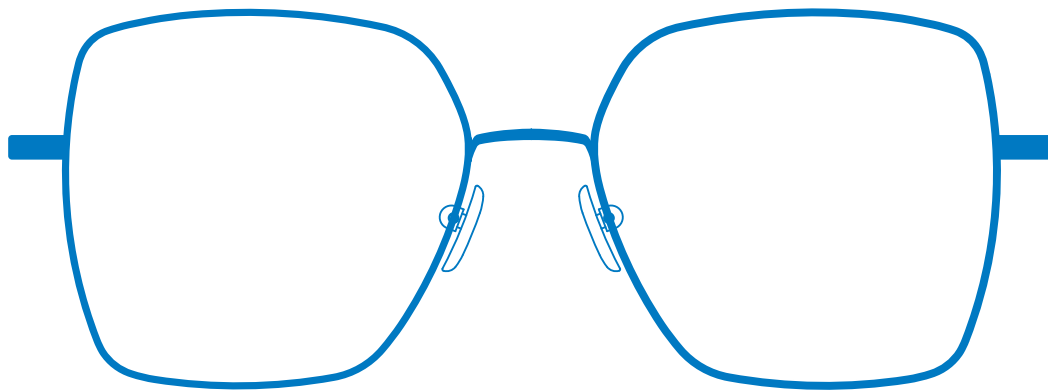

Fixed Clip-On

Suitable for

WIDE SQUARE shapes

■ FOR METAL FRAMES

- Trimmable Lenses
- Anti-scratch hooks
- Case included

FOR FRAME - SIZE 53-55

FIXED



Polarized Lenses 100% UVA-UVB protection up to 390 nm | Filter Category 3 | **CE**



Smoke

Ref. C0271 60 019 001



G15

Ref. C0271 60 019 002



Brown

Ref. C0271 60 019 003

 1 pc.

CE SPECIFICATIONS
IN ACCORDANCE WITH
REGULATION (UE) 2016/425

Case included.



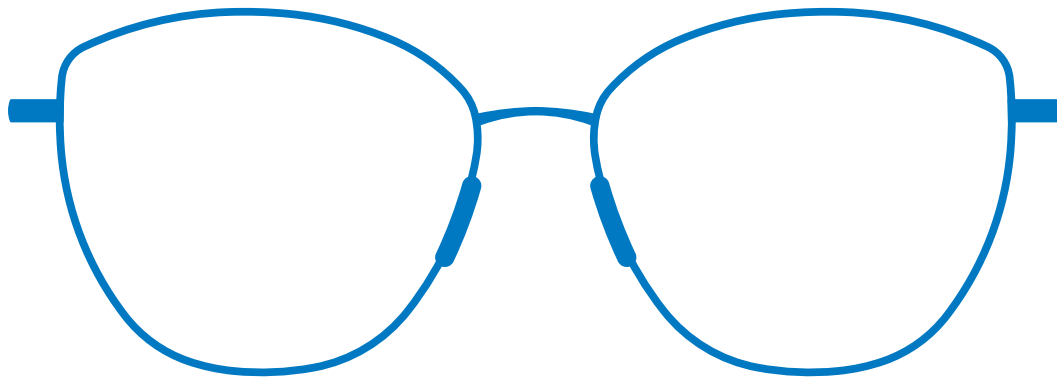

Fixed Clip-On

Suitable for

CAT-EYE shapes

■ FOR METAL FRAMES

- Trimmable Lenses
- Anti-scratch hooks
- Case included

FOR FRAME - SIZE 53-55

FIXED

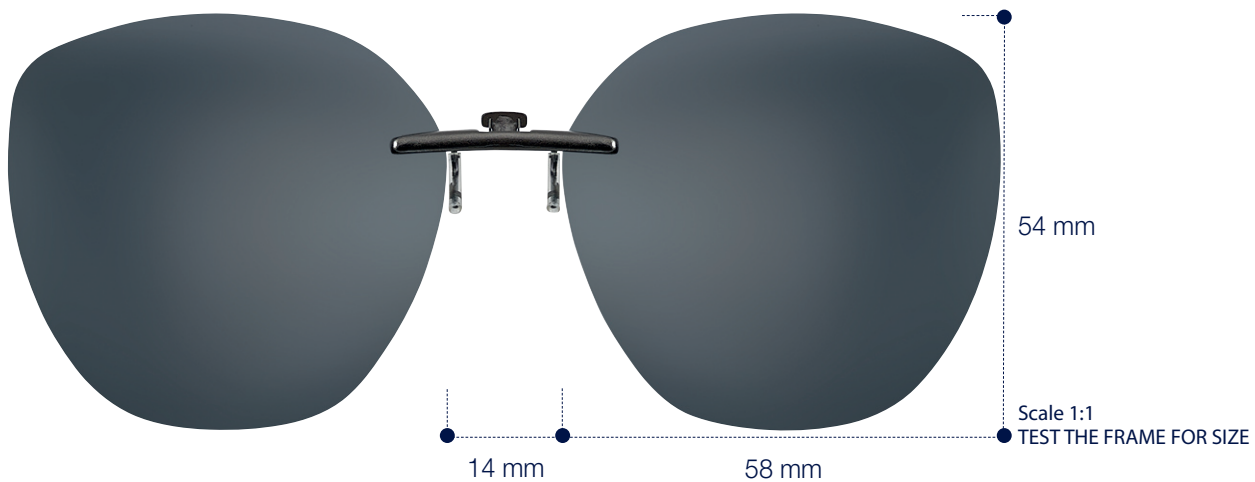

Polarized Lenses 100% UVA-UVB protection up to 390 nm | Filter Category 3 | CE



Smoke

Ref. C0272 58 019 001



G15

Ref. C0272 58 019 002



Brown

Ref. C0272 58 019 003

1 pc.

CE SPECIFICATIONS
IN ACCORDANCE WITH
REGULATION (UE) 2016/425

Case included.





CLIP-ON TRIMMABLE/FIXED

Clip-ons with **trimmable lenses** and **anti-scratch hooks**. **Polarized lenses** for maximum UVA-UVB protection. **Ideal for any shape of frames.**

■ FOR METAL FRAMES

- Trimmable Lenses
- Anti-scratch hooks
- Case included

Polarized Lenses 100% UVA-UVB protection up to 390 nm | Filter Category 3 | CE

FIXED

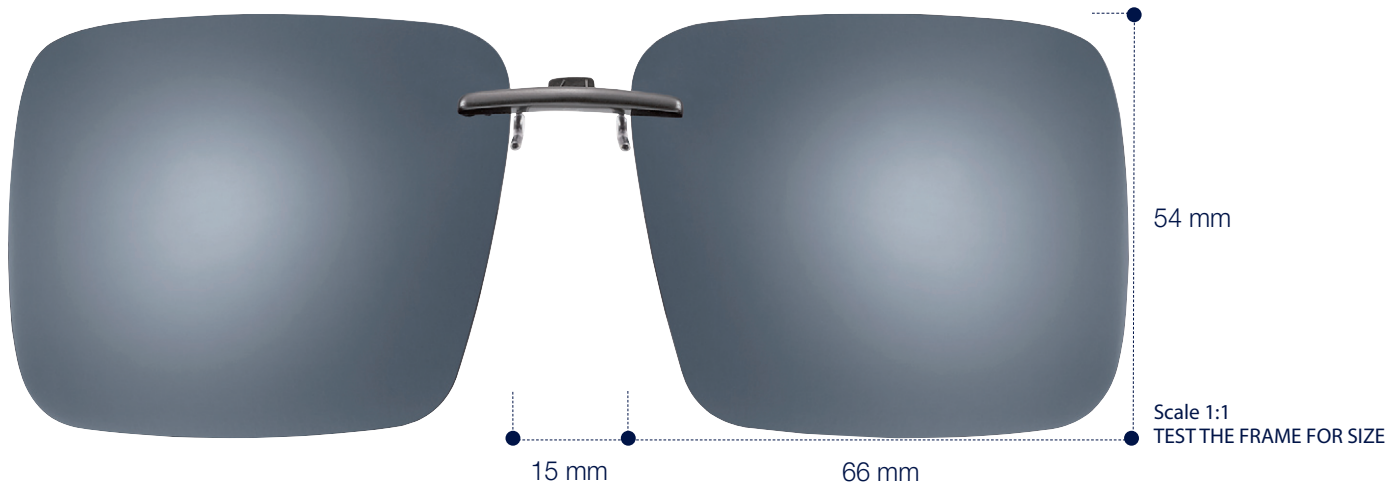

Grey

Ref. 12759



G15

Ref. 12760

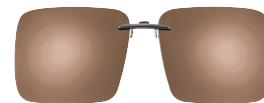

Brown

Ref. 12761

 1 pc.



Yellow FC 1

Ref. 12807

 1 pc.

Case included.



CLIP-ON TRIMMABLE/FLIP-UPS

Flip-Ups with **minimal mechanism**.

Easy to put on and take off by **pressing the central spring**.

Polarized lenses for maximum protection against UVA and UVB rays.



Ref. 11348
Window showcard
on demand
Size: 21x29,7 cm



FOR ALL KIND OF FRAMES

Ref. CK0003

Kit of 12 clip-on of your choice

Minimal mechanism for **plastic** and **metal** frame.



Ref. 11277

Only Couvette



CLIP-ON FLIP-UPS WITH MINIMAL MECHANISM

FOR **PLASTIC** AND **METAL**
FRAMES



**Only one advice
for correct use:**

- Do not use force

1.

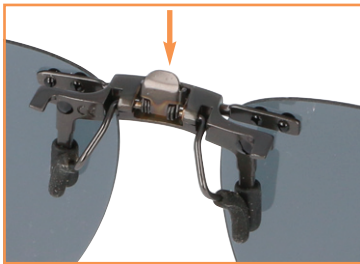

2.

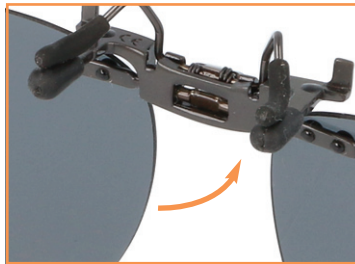

3.

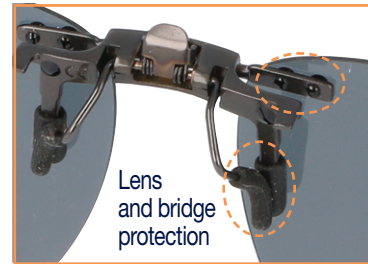

Backing card with technical data and indication of size.

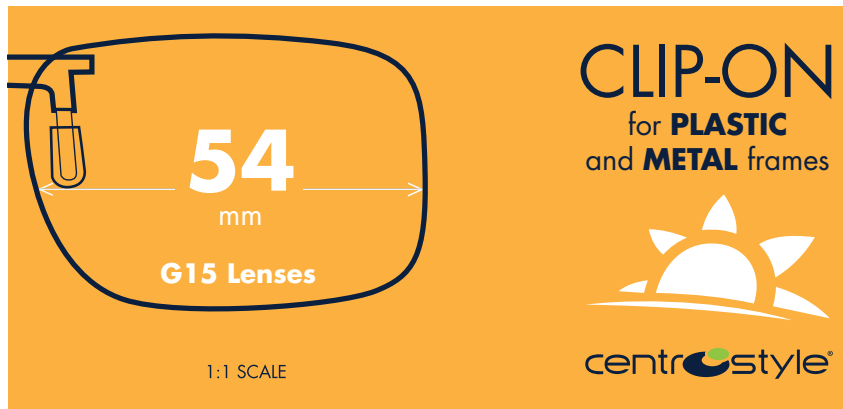

Test the frame for size.

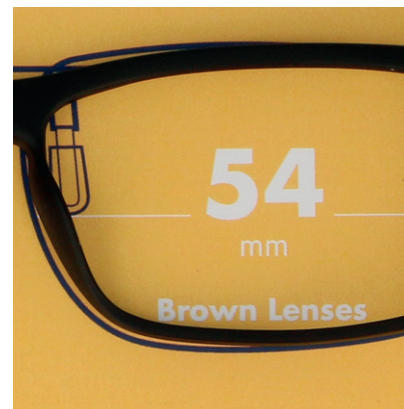

FOR PLASTIC AND METAL FRAMES

- Trimmable Lenses
- Anti-scratch hooks
- Case included

FOR FRAME - SIZE 49-53

FLIP-UPS

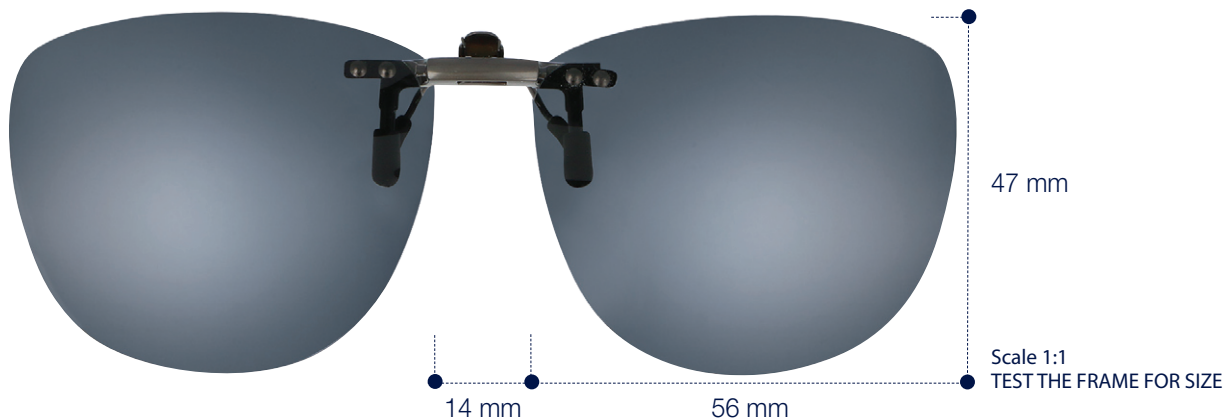

Polarized Lenses 100% UVA-UVB protection up to 390 nm | Filter Category 3 | CE



Grey

Ref. C0061 56 019 001



G15

Ref. C0061 56 019 002



Brown

Ref. C0061 56 019 003



Blue Multilayer Mirror

Ref. C0061 56 019 008



Silver Mirror

Ref. C0061 56 019 024

1 pc.

CE SPECIFICATIONS
IN ACCORDANCE WITH
REGULATION (UE) 2016/425

Case included.



FOR PLASTIC AND METAL FRAMES

- Trimmable Lenses
- Anti-scratch hooks
- Case included

Polarized Lenses 100% UVA-UVB protection up to 390 nm | Filter Category 3 | CE

FLIP-UPS

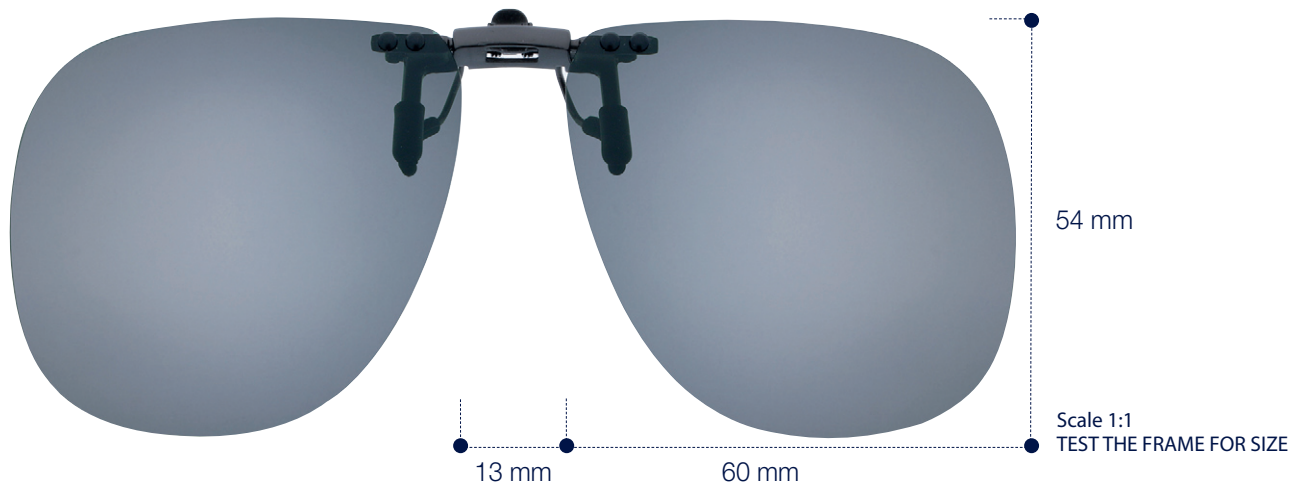

Brown

Ref. C0062 60 019 003



Grey

Ref. C0062 60 019 001



G15

Ref. C0062 60 019 002

1 pc.

Case included.



Ref. 03916

Clip-on or triacetate filters (TAC) shaping kit composed of:

- Special marker pen (Ref. 06965)
- Stainless steel scissors (Ref. 03781)
- Flat needle file (Ref. 02908)
- Scalpel knife (Ref. 03785)
- Tray included, suitable for new LMS Cube.



FOR PLASTIC AND METAL FRAMES

- Trimmable Lenses
- Anti-scratch hooks
- Case included

FOR FRAME - SIZE 50-53

FLIP-UPS



Polarized Lenses 100% UVA-UVB protection up to 390 nm | Filter Category 3 | CE



Grey
Ref. 12723



G15
Ref. 12724



Brown
Ref. 12725

 1 pc.

CE SPECIFICATIONS
IN ACCORDANCE WITH
REGULATION (UE) 2016/425

Case included.



FOR PLASTIC AND METAL FRAMES

- Trimmable Lenses
- Anti-scratch hooks
- Case included

FOR FRAME - SIZE 52-54

FLIP-UPS

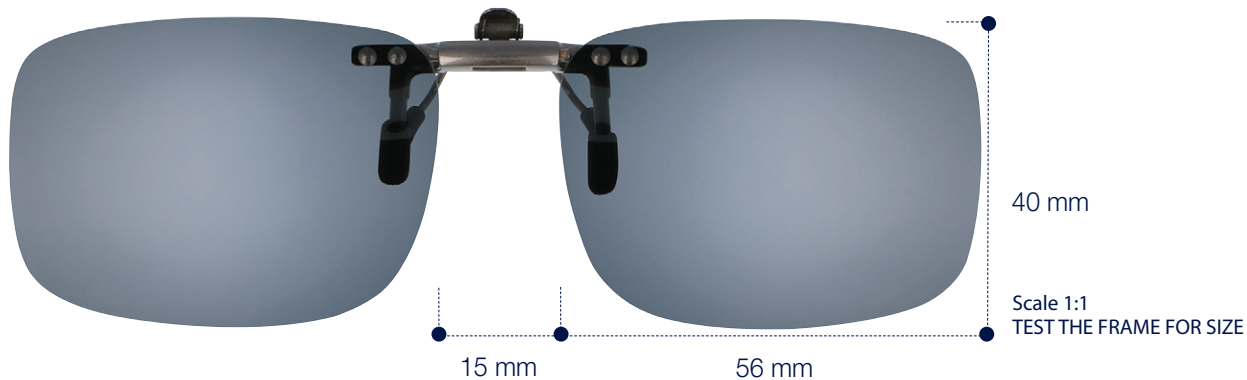

Polarized Lenses 100% UVA-UVB protection up to 390 nm | Filter Category 3 | CE



Grey

Ref. 12726



G15

Ref. 12727



Brown

Ref. 12728

1 pc.

Case included.



Ref. 03916

Clip-on or triacetate filters (TAC) shaping kit composed of:

Special marker pen (Ref. 06965)

Stainless steel scissors (Ref. 03781)

Flat needle file (Ref. 02908)

Scalpel knife (Ref. 03785)

Tray included, suitable for new LMS Cube.



FOR PLASTIC AND METAL FRAMES

- Trimmable Lenses
- Anti-scratch hooks
- Case included

FOR FRAME - SIZE 54-56

FLIP-UPS



Polarized Lenses 100% UVA-UVB protection up to 390 nm | Filter Category 3 | CE



Grey
Ref. 12733



G15
Ref. 12734



Brown
Ref. 12735



Silver Mirror
Ref. 12848



Blue Multilayer Mirror
Ref. 12847

 1 pc.

CE SPECIFICATIONS
IN ACCORDANCE WITH
REGULATION (UE) 2016/425

Case included.



FOR PLASTIC AND METAL FRAMES

- Trimmable Lenses
- Anti-scratch hooks
- Case included

Polarized Lenses 100% UVA-UVB protection up to 390 nm | Filter Category 3 | CE

FLIP-UPS

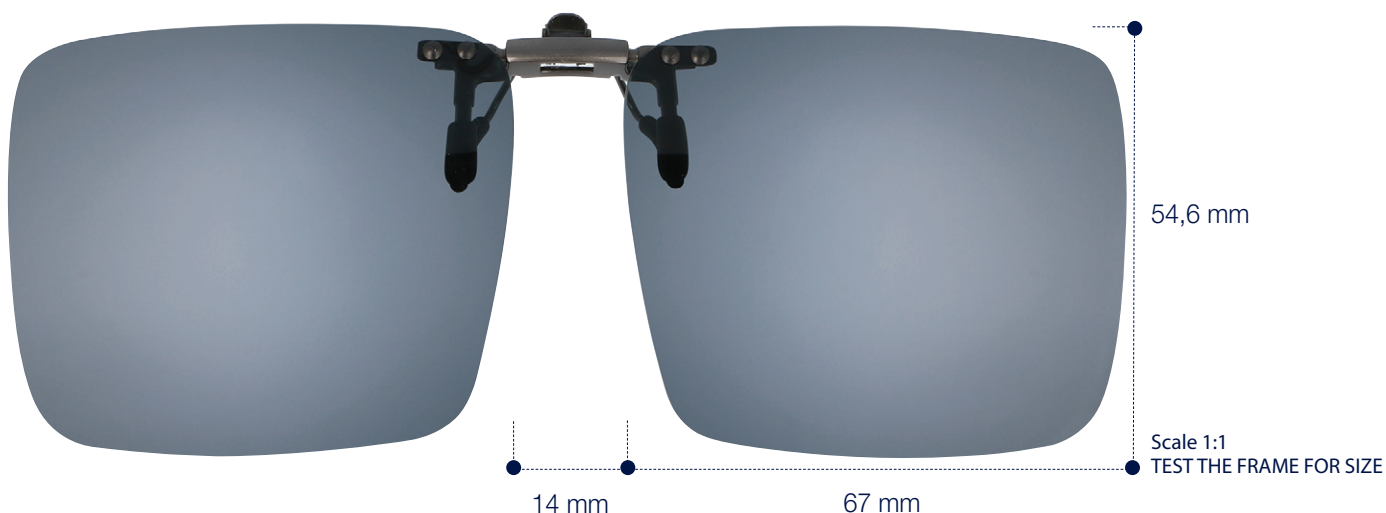

Grey

Ref. 12736

1 pc.



G15

Ref. 12737

1 pc.



Brown

Ref. 12738

1 pc.



Yellow FC 1

Ref. 12808

1 pc.



Blue Light

Ref. 12736BL

1 pc.

Ref. 03916

Clip-on or triacetate filters (TAC) shaping kit composed of:

- Special marker pen (Ref. 06965)
- Stainless steel scissors (Ref. 03781)
- Flat needle file (Ref. 02908)
- Scalpel knife (Ref. 03785)

Tray included, suitable for new LMS Cube.



FOR PLASTIC AND METAL FRAMES

- Trimmable Lenses
- Anti-scratch hooks
- Case included

Polarized Lenses 100% UVA-UVB protection up to 390 nm | Filter Category 3 | **CE**

FLIP-UPS

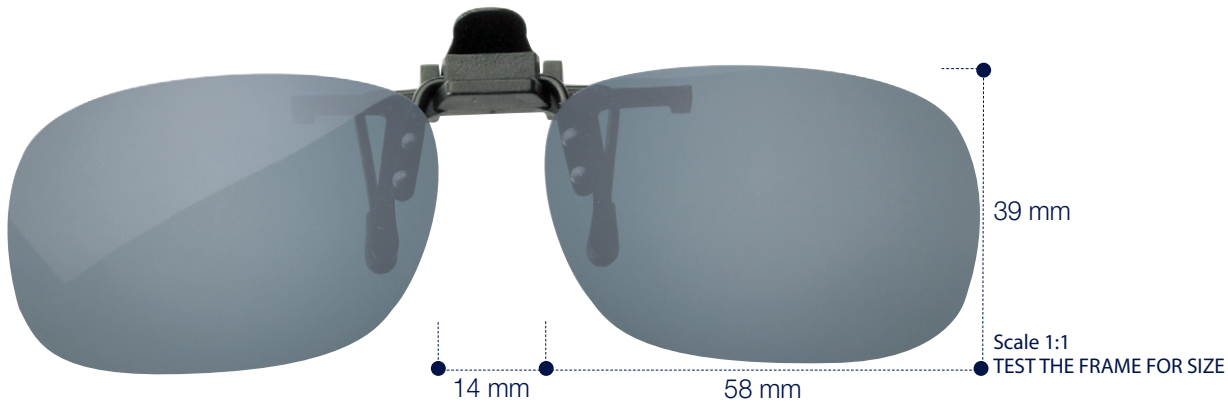

Grey

Ref. 12535/6



Brown

Ref. 12534/6

 6 pcs.

CE SPECIFICATIONS
IN ACCORDANCE WITH
REGULATION (UE) 2016/425

Case included.



FOR PLASTIC AND METAL FRAMES

- Trimmable Lenses
- Anti-scratch hooks
- Case included

Polarized Lenses 100% UVA-UVB protection up to 390 nm | Filter Category 3 | CE

FLIP-UPS



Grey

Ref. 12653



Brown

Ref. 12652

6 pcs.

Ref. 03916

Clip-on or triacetate filters (TAC) shaping kit composed of:

- Special marker pen (Ref. 06965)
- Stainless steel scissors (Ref. 03781)
- Flat needle file (Ref. 02908)
- Scalpel knife (Ref. 03785)
- Tray included, suitable for new LMS Cube.



Case included.



FOR PLASTIC AND METAL FRAMES

- Trimmable Lenses
- Anti-scratch hooks
- Case included

Polarized Lenses 100% UVA-UVB protection up to 390 nm | Filter Category 3 | CE

FLIP-UPS

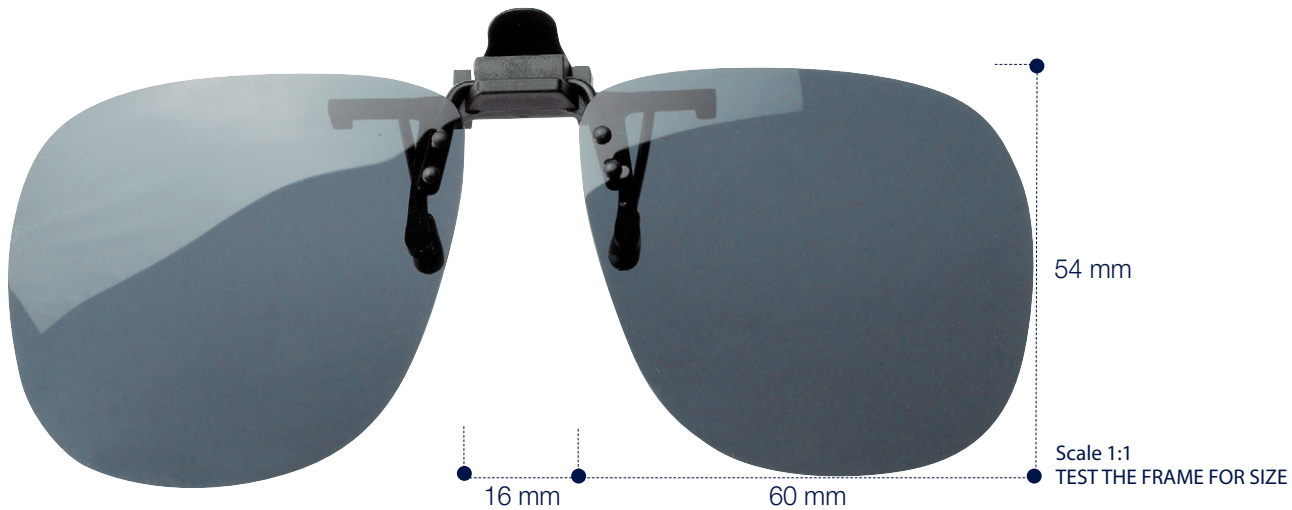

Grey

Ref. 12651



Brown

Ref. 12650

 6 pcs.

CE SPECIFICATIONS
IN ACCORDANCE WITH
REGULATION (UE) 2016/425

Case included.



FOR PLASTIC AND METAL FRAMES

- Trimmable Lenses
- Anti-scratch hooks
- Case included

Polarized Lenses 100% UVA-UVB protection up to 390 nm | Filter Category 3 | CE

FLIP-UPS

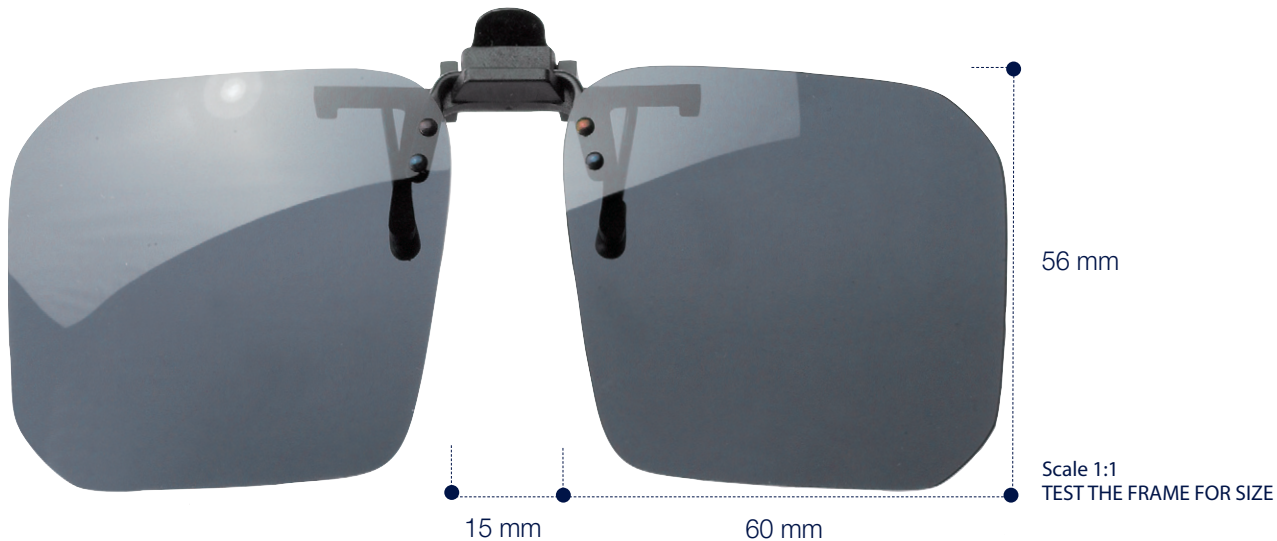

Grey

Ref. 12558



Brown

Ref. 12557

 6 pcs.

Ref. 03916

Clip-on or triacetate filters (TAC) shaping kit composed of:

- Special marker pen (Ref. 06965)
- Stainless steel scissors (Ref. 03781)
- Flat needle file (Ref. 02908)
- Scalpel knife (Ref. 03785)
- Tray included, suitable for new LMS Cube.



Case included.





METAL RIM CLIP-ONS

Clip-Ons with **anti-scratch clips**.

Polarized lenses for maximum protection against **UVA and UVB rays**.



FOR PLASTIC AND METAL FRAMES

- Trimmable Lenses
- Anti-scratch hooks
- Case included

FOR FRAME - SIZE 50-54

FIXED

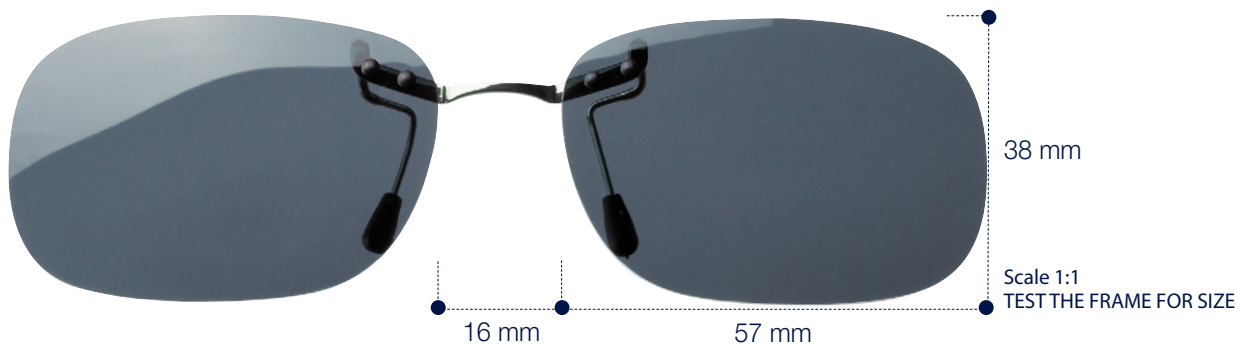

Polarized Lenses 100% UVA-UVB protection up to 390 nm | Filter Category 3 | **CE**



Grey

Ref. 12503/6

 6 pcs.

CE SPECIFICATIONS
IN ACCORDANCE WITH
REGULATION (UE) 2016/425

Case included.



FOR PLASTIC AND METAL FRAMES

- Trimmable Lenses
- Anti-scratch hooks
- Case included

Polarized Lenses 100% UVA-UVB protection up to 390 nm | Filter Category 3 | CE

FIXED

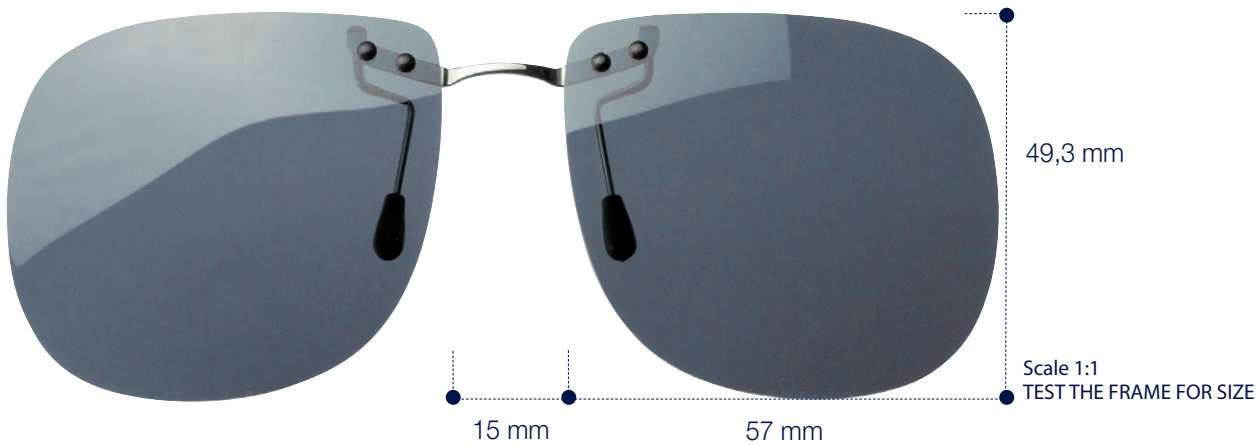

Grey

Ref. 12611

 6 pcs.

Case included.



FOR PLASTIC AND METAL FRAMES

- Trimmable Lenses
- Anti-scratch hooks
- Case included

Polarized Lenses 100% UVA-UVB protection up to 390 nm | Filter Category 3 | **CE**

FIXED

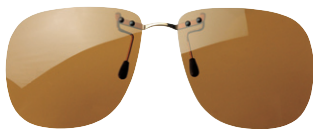
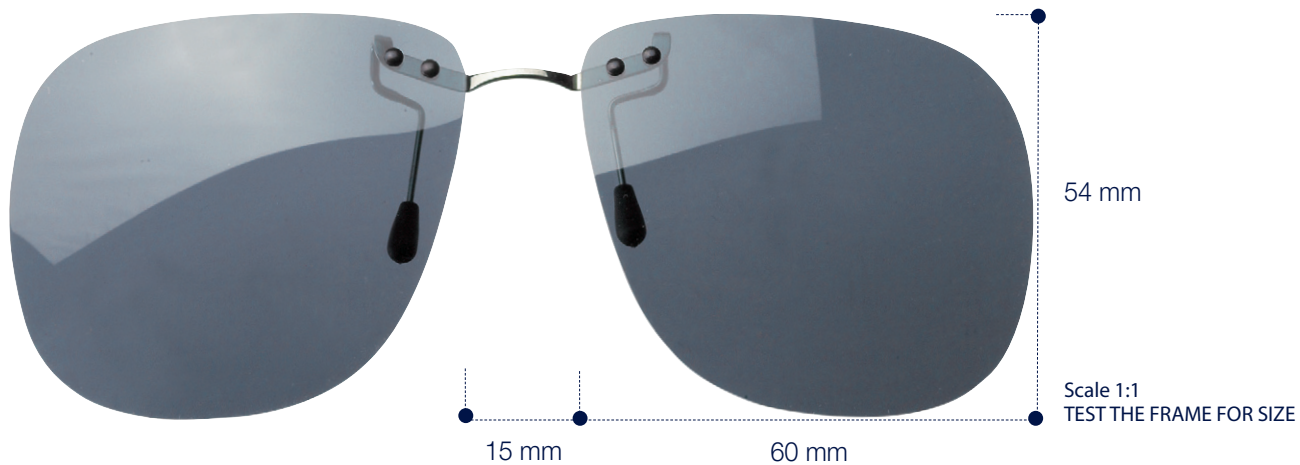

Brown

Ref. 12612



Grey

Ref. 12613

 6 pcs.

CE SPECIFICATIONS
IN ACCORDANCE WITH
REGULATION (UE) 2016/425

Case included.



FOR PLASTIC AND METAL FRAMES

- Trimmable Lenses
- Anti-scratch hooks
- Case included

Polarized Lenses 100% UVA-UVB protection up to 390 nm | Filter Category 3 | CE

FIXED

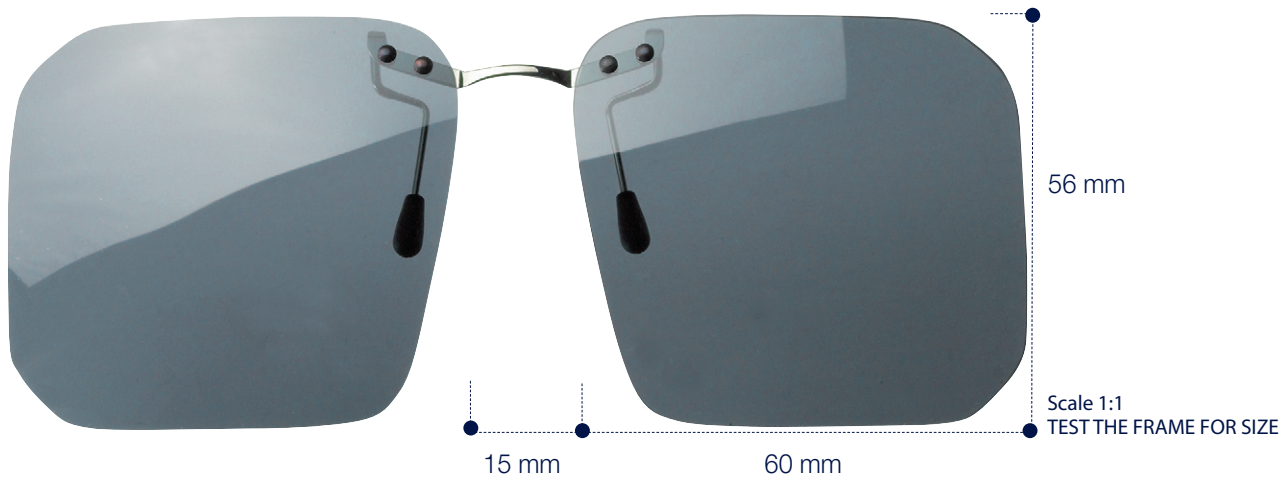

Grey

Ref. 12517

 6 pcs.

Case included.



FOR PLASTIC AND METAL FRAMES

- Anti-scratch hooks
- Case included

FOR FRAME - SIZE 49-51

FIXED

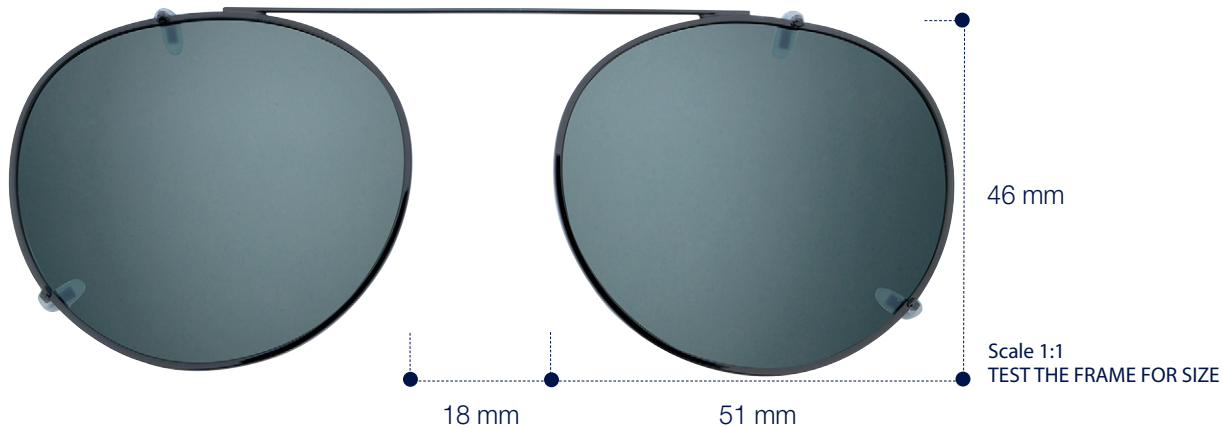

Polarized Lenses 100% UVA-UVB protection up to 390 nm | Filter Category 3 | CE



Gun Metal/G15 Flash Silver Lenses
Ref. C0034 51 019 005

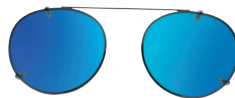

Grey/Blue Multilayer Lenses
Ref. C0034 51 019 008



Grey/Purple Multilayer Lenses
Ref. C0034 51 019 018

CE SPECIFICATIONS
IN ACCORDANCE WITH
REGULATION (UE) 2016/425

Case included.



FOR PLASTIC AND METAL FRAMES

- Anti-scratch hooks
- Case included

FOR FRAME - SIZE 53

FIXED

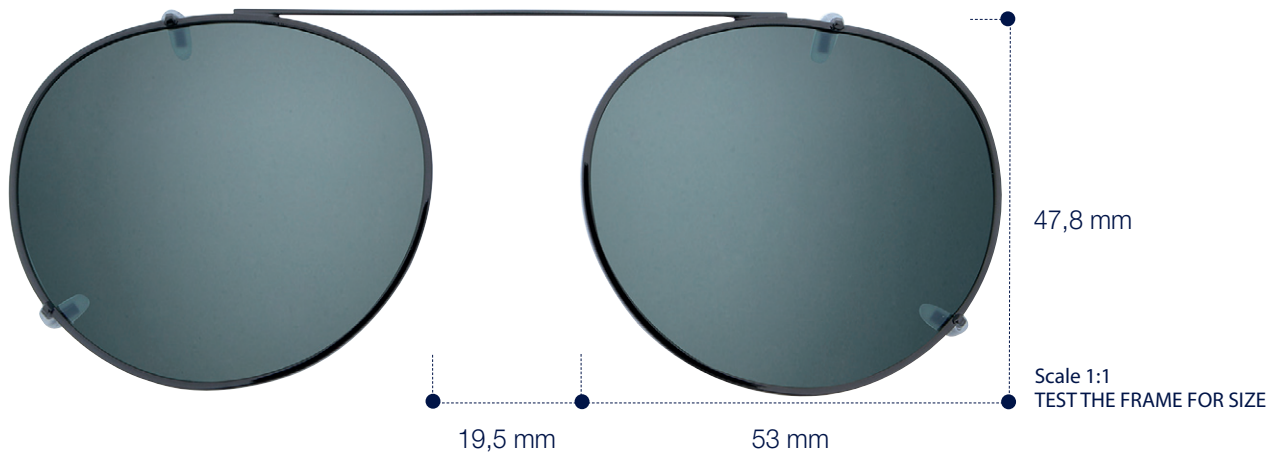

Polarized Lenses 100% UVA-UVB protection up to 390 nm | Filter Category 3 | CE



Gun Metal/G15 Flash Silver Lenses

Ref. C0034 53 019 005

Case included.



FOR PLASTIC AND METAL FRAMES

- Anti-scratch hooks
- Case included

FOR FRAME - SIZE 49-51

FIXED

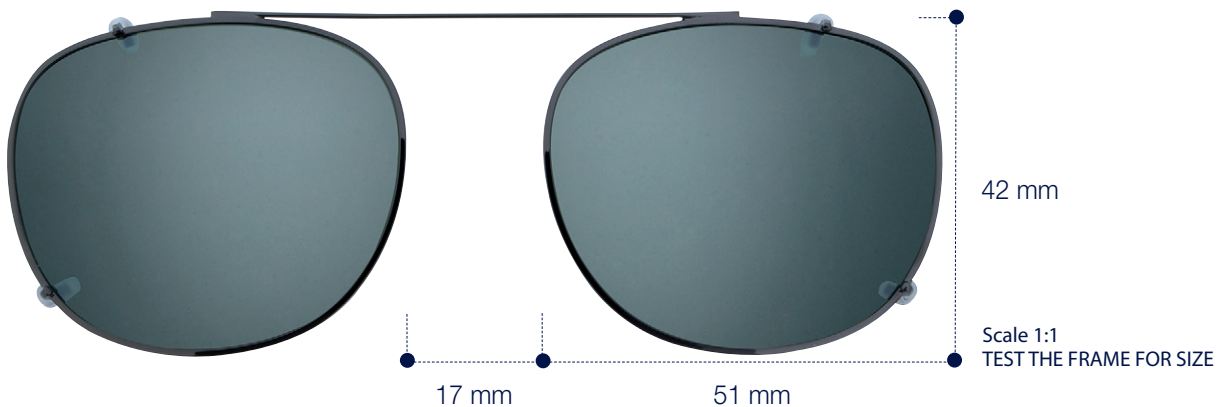

Polarized Lenses 100% UVA-UVB protection up to 390 nm | Filter Category 3 | **CE**



Gun Metal/G15 Lenses
Ref. C0035 51 019 005

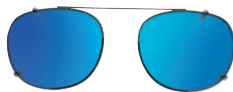

Grey/Blue Multilayer Lenses
Ref. C0035 51 019 008



Grey/Purple Multilayer Lenses
Ref. C0035 51 019 018

CE SPECIFICATIONS
IN ACCORDANCE WITH
REGULATION (UE) 2016/425

Case included.



FOR PLASTIC AND METAL FRAMES

- Anti-scratch hooks
- Case included

FOR FRAME - SIZE 54

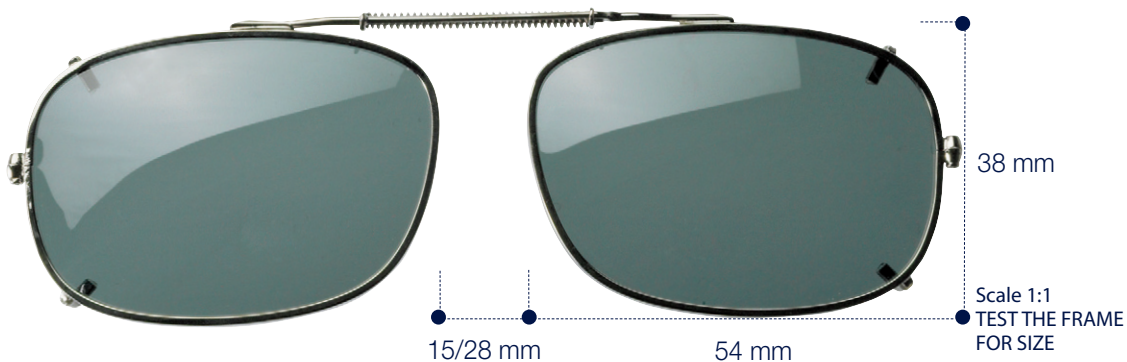

FIXED



Gun Metal/Grey Lenses

Ref. 12461 □ 54 📦 1 pc.

FOR FRAME - SIZE 58

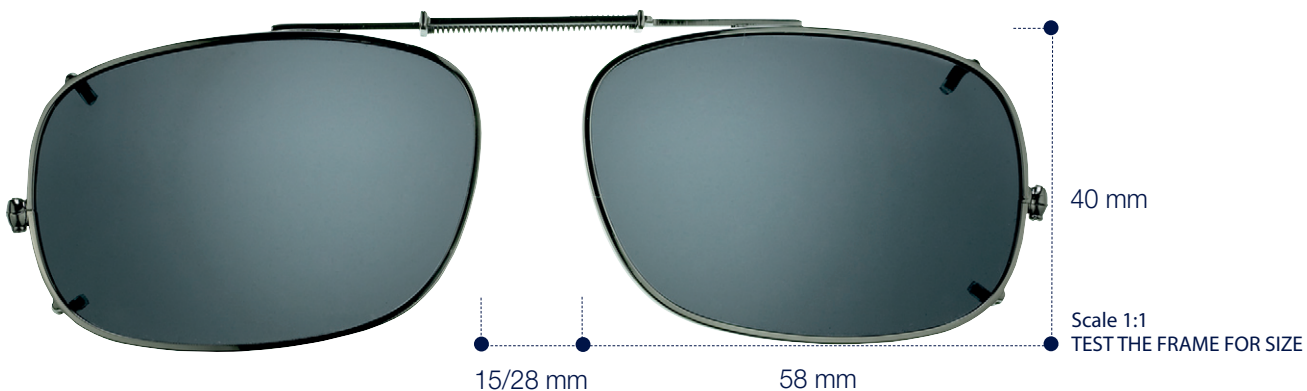

Gun Metal/Grey Lenses

Ref. 12464 □ 58



Gun Metal/G15 Lenses

Ref. 12465 □ 58

📦 1 pc.

SUN-SHIELD

To be worn **over prescription eyewear.**

Protect the eyes 100% from UVA and UVB sun rays. Lightweight and comfortable. The **wrap-around shape** and polarized quality lenses **reduce eye fatigue.**





FOR PLASTIC AND METAL FRAMES

- Grilamid Frame
- Case included

FOR FRAME - SIZE 53

□ 53) 19 B 6 \ 135



Polarized Lenses 100% UVA-UVB protection up to 400 nm | Filter Category 3 | **CE**



Matt Black
Smoke Lenses

Ref. S0084 53 002 001 □ 53



Matt Demy
Brown Lenses

Ref. S0084 53 169 003 □ 53



CE SPECIFICATIONS
IN ACCORDANCE WITH
REGULATION (UE) 2016/425

FOR PLASTIC AND METAL FRAMES

- Grilamid Frame
- Case included

FOR FRAME - SIZE 54

□ 54 ⋈ 17 B 6 ↪ 136



Polarized Lenses 100% UVA-UVB protection up to 400 nm | Filter Category 3 | CE



Shiny Dark Blue
Smoke Lenses

Ref. S0092 54 124 001 □ 54



Shiny Black
Smoke Lenses

Ref. S0092 54 001 001 □ 54



FOR PLASTIC AND METAL FRAMES

- Grilamid Frame
- Case included

FOR FRAME - SIZE 59

□ 59 ⌒ 15 ⊕ 6 ⌒ 145



Polarized Lenses 100% UVA-UVB protection up to 400 nm | Filter Category 3 | CE



Black/Smoke Lenses

Ref. 12703 □ 59



Demi Brown/Brown Lenses

Ref. 12704 □ 59

CE SPECIFICATIONS
IN ACCORDANCE WITH
REGULATION (UE) 2016/425

FOR PLASTIC AND METAL FRAMES

- Grilamid Frame
- Case included

FOR FRAME - SIZE 60

□ 60 ⋈ 15 B 6 ↪ 150



Polarized Lenses 100% UVA-UVB protection up to 400 nm | Filter Category 3 | CE



Black/Smoke Lenses

Ref. 12705 □ 60



Demi Brown/Brown Lenses

Ref. 12706 □ 60

FOR PLASTIC AND METAL FRAMES

- Grilamid Frame
- Case included

FOR FRAME - SIZE 62

□ 62 ⌵ 13 Ⓚ 6 ⌒ 145



Polarized Lenses 100% UVA-UVB protection up to 400 nm | Filter Category 3 | CE



Black/Smoke Lenses
Ref. 12707 □ 62



Demi Brown/Brown Lenses
Ref. 12708 □ 62



CE SPECIFICATIONS
IN ACCORDANCE WITH
REGULATION (UE) 2016/425

FOR PLASTIC AND METAL FRAMES

- Grilamid Frame
- Case included

FOR FRAME - SIZE 57

□ 57 ⌒ 16 B 6 ↪ 145



Polarized Lenses 100% UVA-UVB protection up to 400 nm | Filter Category 3 | CE



Matt Black
Smoke Lenses

Ref. 12716 □ 57



Matt Demi
Brown Lenses

Ref. 12717 □ 57

FOR PLASTIC AND METAL FRAMES

- Grilamid Frame
- **2 sets of Lenses**
- Case included

FOR FRAME - SIZE 63

□ 63) 15 B 6 ~ 140



Polycarbonate Lenses 100% UVA-UVB protection up to 400 nm | Filter Category 3 | CE



Black/Smoke Flash Mirror Lenses FC 3

Ref. 12700 □ 63



INCLUDED

Orange Lenses FC1



Bronze/Brown Flash Mirror Lenses FC 3

Ref. 12702 □ 63



INCLUDED

Orange Lenses FC1



Smoke Flash Mirror Lenses FC 3

Ref. 12700LS

INDIVIDUALLY SELLABLE



CE SPECIFICATIONS
IN ACCORDANCE WITH
REGULATION (UE) 2016/425

Side shields with polarized
filters and slip-proof temple
tip inserts.

ORANGE LENSES

To neutralize the excess of blue light
and its negative effects, allowing a
clear vision and a better visual comfort
(cloudy and foggy weather).

Lenses easy to interchange
thanks to click on shape.



VISIBILITY



Ref. CK0001
12 pcs.
1 pz / Ref.



Ref. CK0002
12 pcs.
1 pz / Ref.

Ref. CK0003
12 pcs.
1 pz / Ref.





Ref. 11277
Only Couvette

Ref. 11346
Window showcard
on demand
Size: 21x29,7 cm

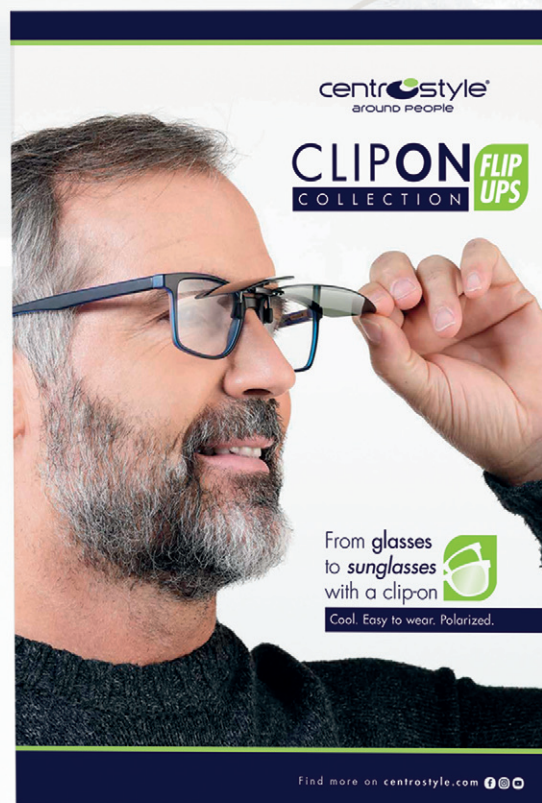

Ref. 11348
Window showcard
on demand
Size: 21x29,7 cm





centrostyle.com 